

GND-5621Ex-Fx (DUAL DIGIT LED DISPLAY)

GND-5621 Series

GND-5621Ex

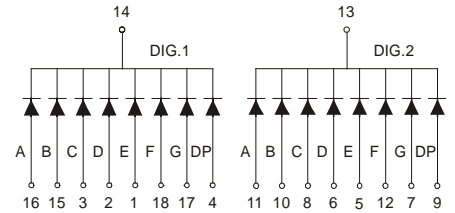
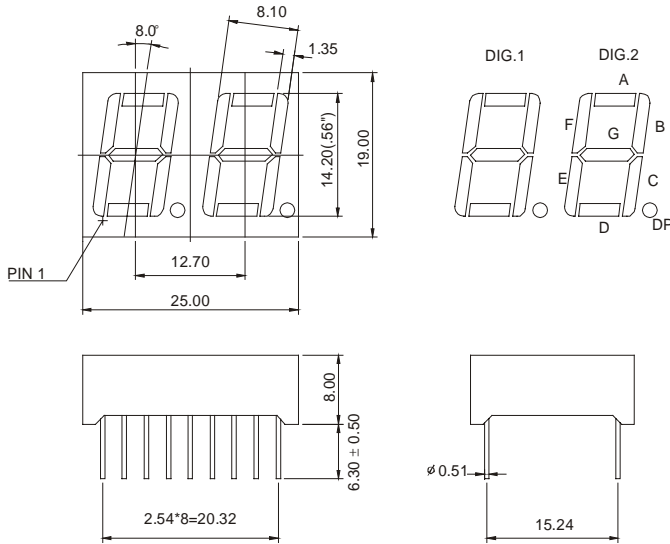

GND-5621Fx

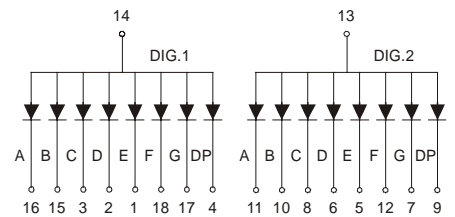

Features:

*0.56 INCH HIGH CHARACTER.

*EXCELLENT CHARACTER APPEARANCE.

*COMMON CATHODE OR COMMON ANODE.

*I.C. COMPATIBLE.

*LOW POWER CONSUMPTION.

Part Number	EMITTED COLOR		Common Cathode or Common Anode	Peak Wavelength (nm)	Vf (v) Typ	If (mA)	Intensity Per Segment (mcd)	
							Min.	Typ.
GND-5621EE	GaAsP/GaP	Hi.effi Red	Common Cathode	635	2.0	20	9	12
GND-5621EG	GaP	Green		565	2.1	20	8	11
GND-5621EY	GaAsP/GaP	Yellow		585	2.0	20	9	12
GND-5621ES	GaAlAs	Super Red		660	1.8	20	10	13
GND-5621ED	GaAlAs	Ultra Red		660	1.8	20	25	30
GND-5621EUE	AlGaInP	Ultra Red		625	2.0	20	30	35
GND-5621EUY	AlGaInP	Ultra Yellow		590	2.0	20	30	35
GND-5621FE	GaAsP/GaP	Hi.effi Red	Common Anode	635	2.0	20	9	12
GND-5621FG	GaP	Green		565	2.1	20	8	11
GND-5621FY	GaAsP/GaP	Yellow		585	2.0	20	9	12
GND-5621FS	GaAlAs	Super Red		660	1.8	20	10	13
GND-5621FD	GaAlAs	Ultra Red		660	1.8	20	25	30
GND-5621FUE	AlGaInP	Ultra Red		625	2.0	20	30	35
GND-5621FUY	AlGaInP	Ultra Yellow		590	2.0	20	30	35