

## Radial MLCC Multilayer Ceramic Capacitors

### Feature

- Miniature size, wide capacitance, tape and reel packaging available for auto-placement.
- Coating by epoxy resin, creates the excellent humidity resistance and prevents body from damaging during soldering and washing.
- Industry standard size and various load spacing available.

### Specification

T.C	NPO/COG	X7R(B)	Y5V(Y/F)	Z5U(E)
Dielectric type	Stable Class I Dielectric	Stable Class II Dielectric		
Electrical properties	With negligible dependence of electrical properties on temperature, voltage, frequency and time	With predictable change of properties with temperature, voltage, frequency and time, this dielectric is ferroelectric and offers higher capacitance ranges than Class I.	With high twist dielectric constant and greater variation of properties with temperature and test conditions, very high capacitance per unit volume.	
Application	Use in circuits requiring stable performance	Use as blocking, coupling, By-passing discriminating element.	Suited for By-passing and coupling application such as store power and memory circuit	
Capacitance range	1pF~10nF	100pF~5uF	1nF~14.7uF	
Operating temperature	0±30PPm/c -55°C~+125°C	±15% -55°C~+125°C	+30%~-80% -25°C~+85°C	+22%~-56% -10°C~+85°C

◆ Electrical Properties standard

Item	Test standard			
	NPO/CG/GH/RH/UJ/SL	X7R(B)	Z5U(E)	Y5V(Y/F)
Capacitance	±5%	±10%	+80-20%	±20%
Dissipation Factor	<0.15%	<3.5%	<5%	<7.5%(200nF)
				<10% (220~470nF)
				<15%(470~1000nF)
Insulation Resistance	<10nF	<25nF	<25nF	<25nF
	IR<1000C0M Ω	IR>25nF	IR>25nF	IR>25nF
	C>10nF	C>25nF	C>25nF	C>25nF
	R • C>100S	R • C>100S	R • C>100S	R • C>100S
Withstanding Voltage	2.5 rated voltage	2.5 rated voltage	2.5 rated voltage	2.5 rated voltage
Test Condition				
Test Frequency	1 MHZ (C>1000PF 1KHz)	1KHz	1KHz	1KHz
Test Voltage of Cap.&D.F	1 ± 0.2V	1 ± 0.2V	0.3 ± 0.2V	0.3 ± 0.2V
Test Voltage of IR	Rated Voltage	Rated Voltage	Rated Voltage	Rated Voltage
Temperature	10~25°C	10~25°C	10~25°C	10~25°C
Humidity	<75%	<75%	<75%	<75%

■Part number: \_\_\_\_\_ :

CT4	---	0805	Y	104	M	500	PF3	R
↓		↓	↓	↓	↓	↓	↓	↓
<b>A</b>		<b>B</b>	<b>C</b>	<b>D</b>	<b>E</b>	<b>F</b>	<b>G</b>	<b>H</b>

<b>A:</b>
<b>Product Type</b>

<b>D:</b>
<b>Capacitance</b>
First two digits are significant third digit is number of zeros. For Example: 104=100000pF 5R6=5.6pF

<b>F:</b>
<b>Rated Voltage</b>
The code meaning is same as capacitance. For Example: 250=25V 500=50V 101=100V

<b>B:</b>	
<b>Unit : Inches</b>	
<b>Cmos Chip Size (LxW)</b>	
<b>Code</b>	<b>Chip</b>
0805	0.08x0.05
1206	0.12x0.06
1210	0.12x0.10
1812	0.18x0.12
2225	0.22x0.25
3035	0.30x0.35

<b>E:</b>	
<b>Tolerance</b>	
<b>B</b>	±0.10pF
<b>C</b>	±0.25pF
<b>D</b>	±0.5pF
<b>F</b>	±1.0%
<b>G</b>	±2.0%
<b>J</b>	±5.0%
<b>K</b>	±10%
<b>M</b>	±20%
<b>N</b>	±30%
<b>S</b>	+50% -20%
<b>Z</b>	+80% -20%
<b>P</b>	+100% -0%
B.C.D for C<10pF NPO: B.C.D.F.G.J.K.M. X7R: K.M.S.Z. Y5V: M.S.Z.P.	

<b>G:</b>		
<b>Packaging Style</b>		
<b>Ammo</b>	PF1	2.54mm
	PF3	5.08mm
<b>Bulk</b>	F1	2.54mm
	F2	4.57mm
	F3	5.08mm
	F4	7.50mm
	F5	3.50mm

<b>C:</b>	
<b>Dielectric</b>	
<b>N</b>	COG/NPO
<b>B</b>	X7R
<b>Y</b>	Y5V
<b>E</b>	Y5U/Z5U

<b>H:</b>	
<b>Pb</b>	
<b>R</b>	RoHS

## Radial MLCC Multilayer Ceramic Capacitors

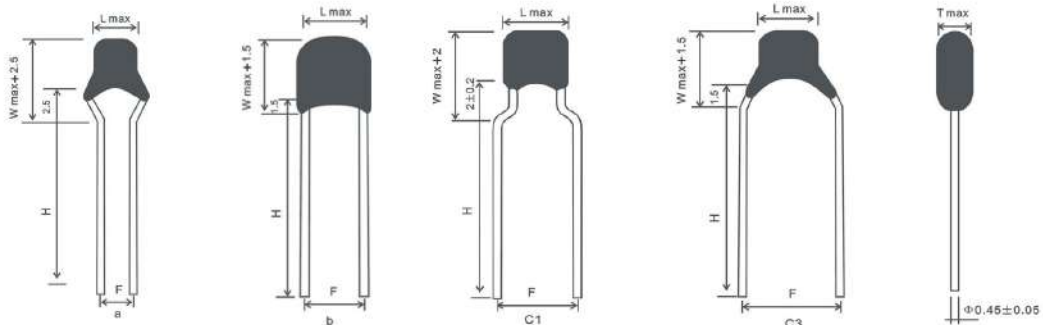

Size Code	Shape	Dimensions (mm)					voltage	Capacitance(pF)		
		F (±0.5)	Hmin (±1)	Lmax	Wmax	Tmax		NPO	X7R	Y5V
<b>0805</b>	a	2.54	5.0							
	b	2.54	10.0							
	C1	5.08	5.0/10.0	4.2	3.8	3.8	25V 50V 100V	0R5~332 0R5~222 0R5~102	331~104 331~104 331~104	103~105 103~105 103~684
	C2	5.08	5.0							
C3	5.08	5.0/10.0								
<b>1206</b>	a	2.54								
	b	3.50	10.0	5.0	4.5	3.8	25V 50V 100V	0R5~682 0R5~472 0R5~392	102~224 102~104 102~105	103~125 103~105
	C1	5.08								
<b>1210</b>	b	3.50	10.0	7.6	5.5	3.8	25V 50V 100V	0R5~103 0R5~472 0R5~392	102~334 102~224 102~105	104~155
	C1	5.08								
<b>1812</b>	b	4.57	10.0	8.5	8.5	3.8	25V 50V 100V	561~103 561~682 561~472	103~474 103~334 103~105	154~335
<b>2225</b>	b	5.50	10.0	10.5	9.5	4.2	25V 50V 100V	102~223 102~223 102~103	103~105 103~105 103~474	684~475
<b>3035</b>	b	7.50	10.0	12.5	10.5	4.2	25V 50V 100V	102~104 102~473 102~333	103~225 103~205 103~105	105~106 105~685

\*Lead spacing determined by customer requirements.

## Radial MLCC Multilayer Ceramic Capacitors

### ■Radial Leads MLCC Packaging Style

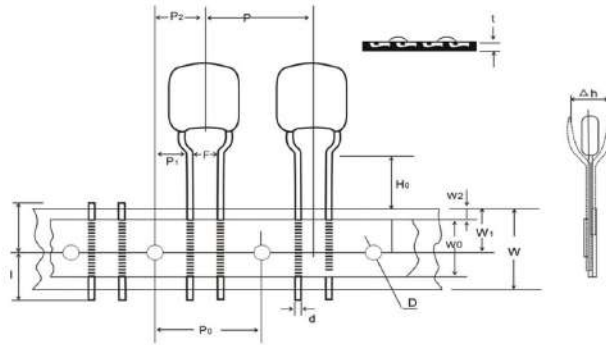

DESCRIPTION	SYMBOL	DIMENSIONS(mm)	REMARKS
PITCH OF COMPONENT	P	12.7±1.0	
FEEDHOLD PITCH	P0	12.7±0.3	CUMULATIVE PITCH ERROR: ±1.0mm/20 PITCHES
FEED HOLD CENTER TO LEAD	P1	3.85±0.7	FOR F:5.08, 5.1±0.7 FOR F:2.54
FEED HOLD CENTER TO COMPONENT CENTER	P2	8.35±1.3	
LEAD TO LEAD SPACING	F	5.08+0.8/-0.2 OR 2.5+0.8/-0.2	TO LEAD TIP WITHIN TOL
COMPONENT ALIGNMENT, F-R	ΔH	2.0max	THE ALIGNMENT FROM THE CENTER OF THE LEAD IS ±1.0mm
TAPE WIDTH	W	18.0±1	
ADHESIVE TAPE WIDTH	W0	12.0±1	
HOLE POSITION	W1	9.0±0.5	
ADHESIVE TAPE POSITION	W2	3.0max	ADHESIVE TAPE MUST NOT PROTRUDE FROM BADE PAPER
LEAD-WIRE CLINCH HEIGHT	H0	15-20±0.5	6.5<=H0-W1
COMPONENT HEIGHT	H1	32.25max	
FEED HOLE DIAMETER	D0	4.0±0.3	
TOTAL TAPE THICKNESS	T	0.7±0.2	

### ■ Ammo Packaging

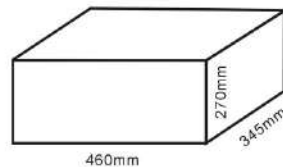
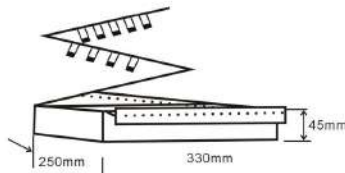

## Capacitance Change VS Temperature Characteristic ; Voltage ; Frequency Profiles

### NPO

(1) Capacitance Change VS Temperature

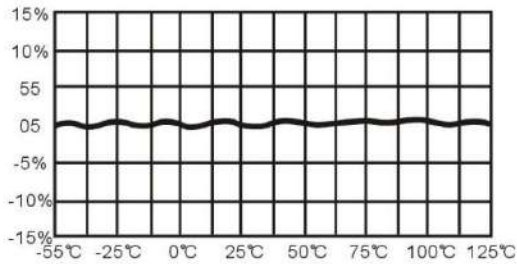

(2) Frequency

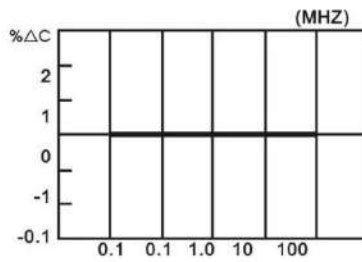

(3) DC voltage

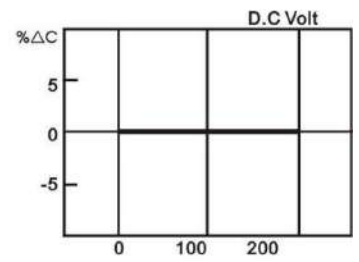

### X7R

(1) Capacitance Change VS Temperature

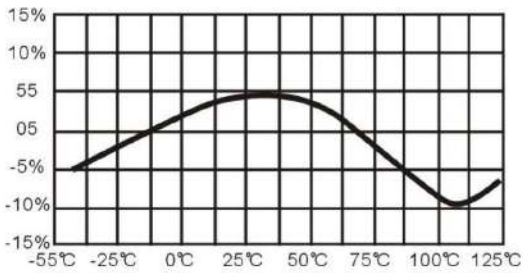

(2) Frequency

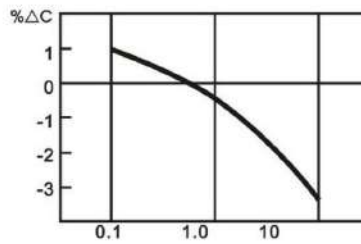

(3) DC voltage

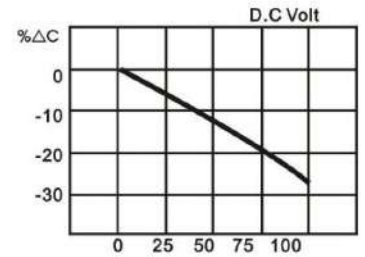

### Z5U

(1) Capacitance Change VS Temperature

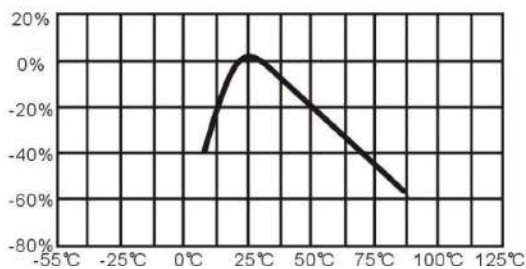

(2) DC voltage

