

Low profile PCB relays 3 - 5 - 8 - 12 - 16 A



Medical and dentistry



Industrial robots



Building automation



Control systems



Timers and lighting controls



Door and gate openers

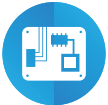

Electronic circuit boards



Vending machines

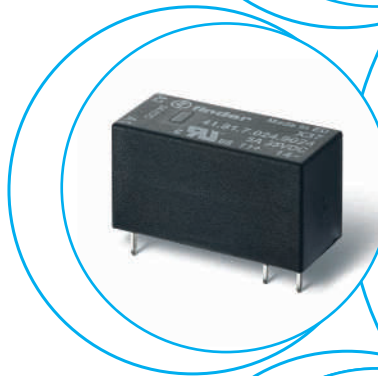

1 & 2 Pole - Low profile (15.7 mm height)

Type 41.31

- 1 Pole 12 A (3.5 mm pin pitch)

Type 41.52

- 2 Pole 8 A (5.0 mm pin pitch)

Type 41.61

- 1 Pole 16 A (5.0 mm pin pitch)

PCB mount

- direct or via PCB socket

35 mm rail mount

- via screw and screwless sockets

- AC and DC coils
- 8 mm, 6 kV (1.2/50 µs) isolation, coil-contacts
- Cadmium Free contact materials
- Flux proof: RT II standard, (RT III option)

**With the AgSnO₂ material the maximum peak current is 80 A - 5 ms on NO contact.

FOR UL RATINGS SEE:

"General technical information" page V

For outline drawing see page 9

Contact specification

Contact configuration	41.31	41.52	41.61
Contact configuration	1 CO (SPDT)	2 CO (DPDT)	1 CO (SPDT)
Rated current/ Maximum peak current	A 12/25	8/15	16/30**
Rated voltage/ Maximum switching voltage	V AC 250/400	250/400	250/400
Rated load AC1	VA 3000	2000	4000
Rated load AC15 (230 V AC)	VA 600	400	750
Single phase motor rating (230 V AC)	kW 0.5	0.3	0.5
Breaking capacity DC1: 24/110/220 V	A 12/0.3/0.12	8/0.3/0.12	16/0.3/0.12
Minimum switching load	mW (V/mA) 300 (5/5)	300 (5/5)	300 (5/5)
Standard contact material	AgNi	AgNi	AgNi

Coil specification

Nominal voltage (U _N)	V AC (50/60 Hz)	41.31	41.52	41.61
	V DC	5 - 6 - 12 - 24 - 48 - 60 - 110	5 - 6 - 12 - 24 - 48 - 60 - 110	5 - 6 - 12 - 24 - 48 - 60 - 110
Rated power AC/DC	VA (50 Hz)/W	0.75/0.4	0.75/0.4	0.75/0.4
Operating range	AC	(0.8...1.1)U _N	(0.8...1.1)U _N	(0.8...1.1)U _N
	DC	(0.7...1.5)U _N	(0.7...1.5)U _N	(0.7...1.5)U _N
Holding voltage	AC/DC	0.8/0.4 U _N	0.8/0.4 U _N	0.8/0.4 U _N
Must drop-out voltage	AC/DC	0.15/0.1 U _N	0.15/0.1 U _N	0.15/0.1 U _N

Technical data

Mechanical life AC/DC	cycles	10 · 10 ⁶ / 10 · 10 ⁶	10 · 10 ⁶ / 10 · 10 ⁶	10 · 10 ⁶ / 10 · 10 ⁶
Electrical life at rated load AC1	cycles	60 · 10 ³	60 · 10 ³	50 · 10 ³
Operate/release time	ms	8/6	8/6	8/6
Insulation between coil and contacts (1.2/50 µs)	kV	6 (8 mm)	6 (8 mm)	6 (8 mm)
Dielectric strength between open contacts	V AC	1000	1000	1000
Ambient temperature range AC/DC	°C	-40...+70/-40...+85	-40...+70/-40...+85	-40...+70/-40...+85
Environmental protection		RT II	RT II	RT II

Approvals (according to type)



41.31	41.52	41.61
<ul style="list-style-type: none"> • 3.5 mm contact pin pitch • 1 Pole 12 A • PCB direct or via socket 	<ul style="list-style-type: none"> • 5.0 mm contact pin pitch • 2 Pole 8 A • PCB direct or via socket 	<ul style="list-style-type: none"> • 5.0 mm contact pin pitch • 1 Pole 16 A • PCB direct or via socket
<p>Copper side view</p>	<p>Copper side view</p>	<p>Copper side view</p>

A

**1 & 2 Pole - Polarized bistable, Low profile
(15.7 mm height)**

Type 41.52

- 2 Pole 8 A (5.0 mm pin pitch)

Type 41.61

- 1 Pole 16 A (5.0 mm pin pitch)

Printed Circuit mount

- Polarized bistable relay with 2 coils
- 10 mm, 6 kV (1.2/50 μ s) isolation, coil-contacts
- Cadmium Free contact materials
- Flux proof: RT II standard

41.52.6.xxx



- 2 Pole, 8 A
- PCB direct mount

41.61.6.xxx



- 1 Pole, 16 A
- PCB direct mount

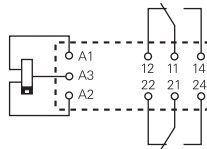

2 coil version:
A3(+) A2 (-) = Set
A3(+) A1 (-) = Reset

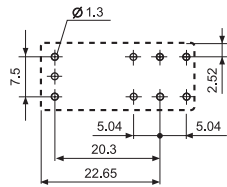

Copper side view

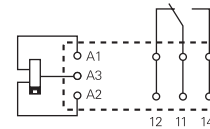

2 coil version:
A3(+) A2 (-) = Set
A3(+) A1 (-) = Reset

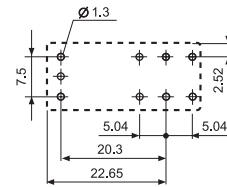

Copper side view

For outline drawing see page 9

Contact specification

Contact configuration		2 CO (DPDT)	1 CO (SPDT)
Rated current/ Maximum peak current (I_N/I_{max})	A	8/15	16/30
Rated voltage/ Maximum switching voltage (U_N/U_{max})	V AC	250/400	250/400
Rated load AC1	VA	2000	4000
Rated load AC15 (230 V AC)	VA	350	750
Single phase motor rating (230 V AC)	kW	0.37	0.55
Breaking capacity DC1: 24/110/220 V	A	8/0.3/0.12	16/0.3/0.12
Minimum switching load	mW (V/mA)	500 (5/100)	500 (5/100)
Standard contact material		AgSnO ₂	AgSnO ₂

Coil specification





Nominal voltage (U_N)	V DC	5 - 12 - 24	5 - 12 - 24
Rated power (P_N)	W	0.65	0.65
Operating range	DC	(0.7...1.1) U_N	(0.7...1.1) U_N
Min. impulse duration	ms	20	20
Max. impulse duration	s	30	30

Technical data

Mechanical life DC	cycles	5 · 10 ⁶	5 · 10 ⁶
Electrical life at rated load AC1	cycles	30 · 10 ³	30 · 10 ³
Operate/release time	ms	10/5	10/10
Insulation between coil and contacts (1.2/50 μ s)	kV	6 (10 mm)	6 (10 mm)
Dielectric strength between open contacts	V AC	1000	1000
Ambient temperature range	°C	-40...+85	-40...+85
Environmental protection		RT II	RT II

Approvals (according to type)

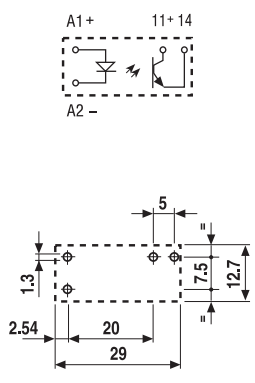
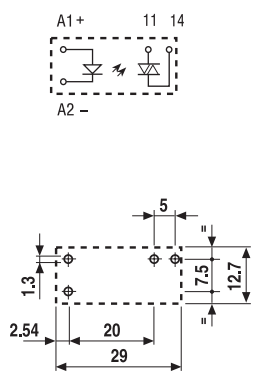

<p>Solid State Relays</p> <p>Printed circuit mount: - direct or via PCB socket</p> <p>35 mm rail mount: - via screw or screwless sockets</p> <ul style="list-style-type: none"> • Single circuit output switching options <ul style="list-style-type: none"> - 5 A 24 V DC - 3 A 240 V AC • Silent, high speed switching with long electrical life • LED indicator • Low profile (15.7 mm) • Wash tight: RT III • 2500 V AC insulation, input-output 	<p>41.81 - 9024</p>  <ul style="list-style-type: none"> • 5 A, 24 V DC output switching • PCB or 93 Series sockets 	<p>41.81 - 8240</p>  <ul style="list-style-type: none"> • 3 A, 240 V AC output switching • Zero crossing switching • PCB or 93 Series sockets 			
	<p>For outline drawing see page 9</p>	 <p>Copper side view</p>	 <p>Copper side view</p>		
<p>Output circuit</p>	<p>Contact configuration: 1 NO (SPST-NO)</p>				
Rated current/	A				
Maximum peak current (10 ms)	5/40				
Rated voltage/	V				
Maximum blocking voltage	(24/35)DC				
Switching voltage range	(1.5...24)DC				
Repetitive peak off-state voltage	V_{pk}				
Minimum switching current	mA				
Max. "OFF-state" leakage current	mA				
Max. "ON-state" voltage drop	V				
Input circuit					
Nominal voltage	V DC	12	24	12	24
Operating range	V DC	8...17	14...32	8...17	14...32
Control current	mA	5.5	9	8.8	9
Release voltage	V DC	4	9	4	9
Impedance	Ω	1550	2600	1030	2600
Technical data					
Operate/release time	ms	0.05/0.25		10/10	
Dielectric strength between input/output	V AC	2500		2500	
Ambient temperature range	$^{\circ}\text{C}$	-20...+60		-20...+60	
Environmental protection		RT III		RT III	
Approvals (according to type)					

Ordering information

Electromechanical relay (EMR)

Example: 41 series low-profile PCB relay, 2 CO (DPDT), 24 V DC coil.

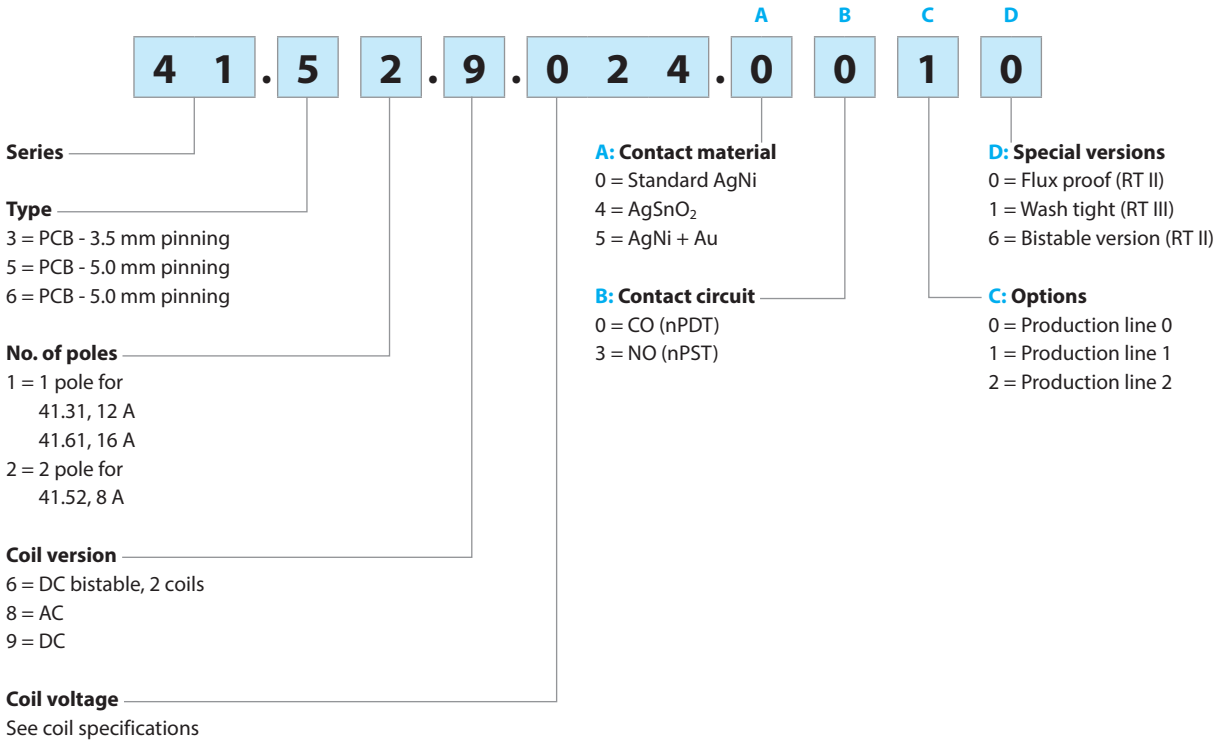

Selecting features and options: only combinations in the same row are possible.
Preferred selections for best availability are shown in **bold**.

Type	Coil version	A	B	C	D
41.31	DC	0 - 4 - 5	0 - 3	1	0 - 1
41.52	DC	0 - 5	0 - 3	1	0 - 1
41.61	DC	0 - 4	0 - 3	1	0 - 1
41.31/61	DC (12-24V)	0	0	2	0
41.31/52/61	AC	0	0	0	0
41.52	DC bistable	4	0	1	6
41.61	DC bistable	4	0 - 3	1	6

Solid state relay (SSR)

Example: 41 series SSR relay, 5 A output, 24 V DC supply.

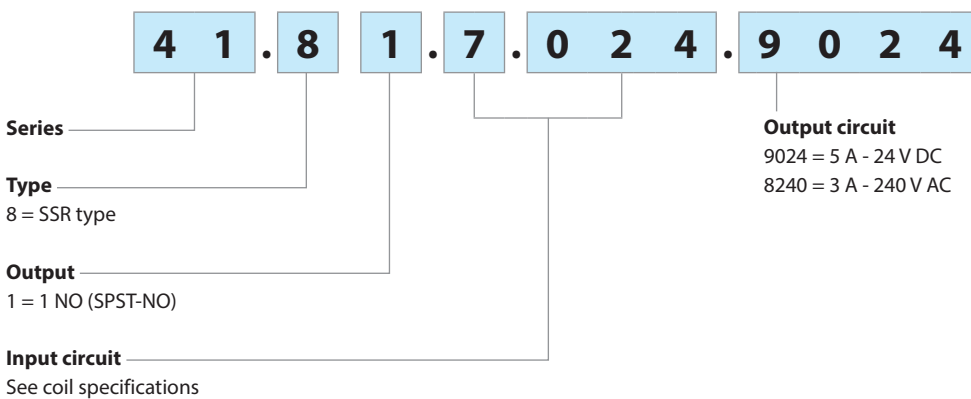

Electromechanical relay

A

Technical data

Insulation according to EN 61810-1							
		1 pole		1 pole bistable	2 pole		2 pole bistable
Nominal voltage of supply system	V AC	230/400		230/400	230/400		230/400
Rated insulation voltage	V AC	250	400	250	250	400	250
Pollution degree		3	2	2	3	2	2
Insulation between coil and contact set							
Type of insulation		Reinforced (8 mm)		Reinforced (10 mm)	Reinforced (8 mm)		Reinforced (10 mm)
Overvoltage category		III		III	III		III
Rated impulse voltage	kV (1.2/50 µs)	6		6	6		6
Dielectric strength	V AC	4000		4000	4000		4000
Insulation between adjacent contacts							
Type of insulation		—		—	Basic		Basic
Overvoltage category		—		—	III		III
Rated impulse voltage	kV (1.2/50 µs)	—		—	4		4
Dielectric strength	V AC	—		—	2000		2000
Insulation between open contacts							
Type of disconnection		Micro-disconnection			Micro-disconnection		
Dielectric strength	V AC/kV (1.2/50 µs)	1000/1.5			1000/1.5		
Insulation between coil terminals							
Rated impulse voltage (surge) differential mode (according to EN 61000-4-5)	kV (1.2/50 µs)	2					
Other data							
Bounce time: NO/NC	ms	4/6 (monostable) - 2/10 (bistable)					
Vibration resistance (5...55)Hz: NO/NC	g	15/2 (monostable) - 5/3 (bistable)					
Shock resistance	g	16 (monostable) - 10 (bistable)					
Power lost to the environment	without contact current	W	0.4 (monostable)				
	with rated current	W	1.7 (41.31)	1.2 (41.52)	1.8 (41.61)		
Recommended distance between relays mounted on PCB	mm	≥ 5					

Contact specification

F 41 - Electrical life (AC) v contact current (monostable)

Types 41.31/61

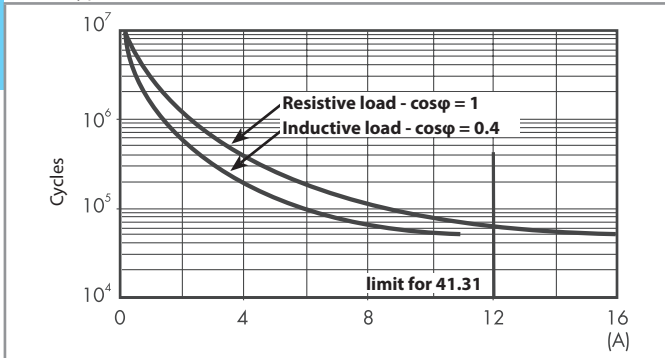

F 41 - Electrical life (AC) v contact current (monostable)

Type 41.52

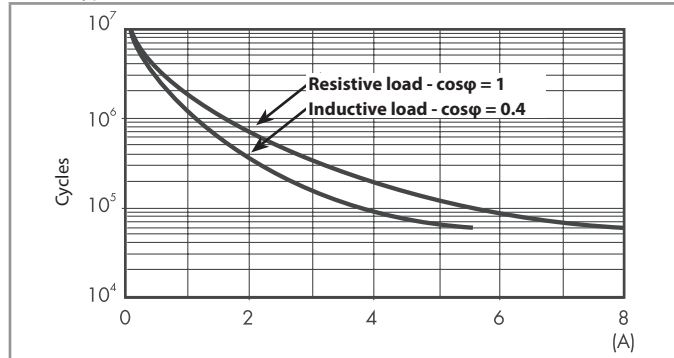

F 41 - Electrical life (AC) v contact current (bistable)

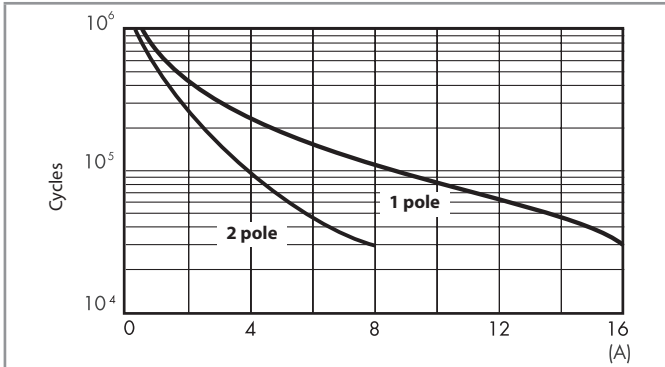

H 41 - Maximum DC1 breaking capacity

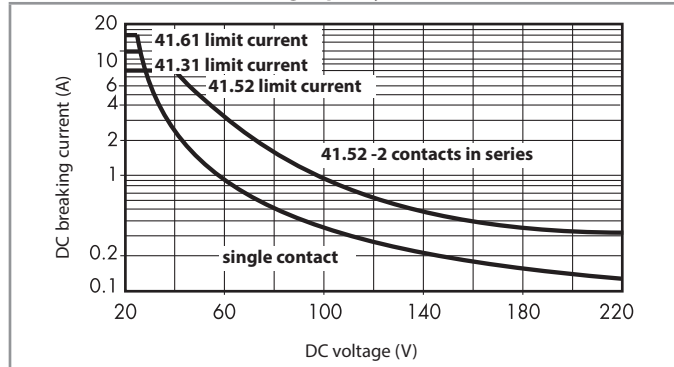

- When switching a resistive load (DC1) having voltage and current values under the curve, an electrical life of $\geq 100 \cdot 10^3$ can be expected.
- In the case of DC13 loads, the connection of a diode in parallel with the load will permit a similar electrical life as for a DC1 load. Note: the release time for the load will be increased.

Coil specifications

AC coil data

Nominal voltage U_N V	Coil code	Operating range		Resistance R Ω	Rated coil consumption I at U_N mA
		U_{min} V	U_{max} V		
24	8.024	19.2	26.4	350	31.6
230	8.230	184	253	32500	3.2

DC coil data

Nominal voltage U_N V	Coil code	Operating range		Resistance R Ω	Rated coil consumption I at U_N mA
		U_{min} V	U_{max} V		
5	9.005	3.5	7.5	62	80
6	9.006	4.2	9	90	66.7
12	9.012	8.4	18	360	33.3
24	9.024	16.8	36	1440	16.7
48	9.048	33.6	72	5760	8.3
60	9.060	42	90	9000	6.6
110	9.110	77	165	24200	4.5

DC coil data (bistable)

Nominal voltage U_N V	Coil code	Operating range			Resistance R Ω	Rated coil power I at U_N mW
		Set U_{min} V	Reset U_{min} V	Set/Reset U_{max} V		
5	6.005	3.5	3.5	5.5	38	650
12	6.012	8.4	8.4	13.2	220	650
24	6.024	16.8	16.8	26.4	885	650

R 41 - AC coil operating range v ambient temperature

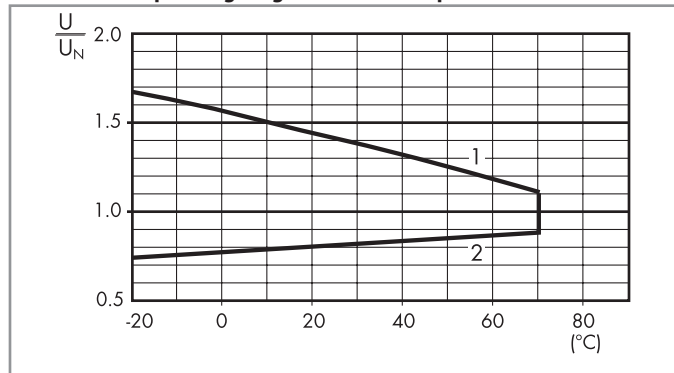

- 1 - Max. permitted coil voltage.
- 2 - Min. pick-up voltage with coil at ambient temperature.

R 41 - DC coil operating range v ambient temperature

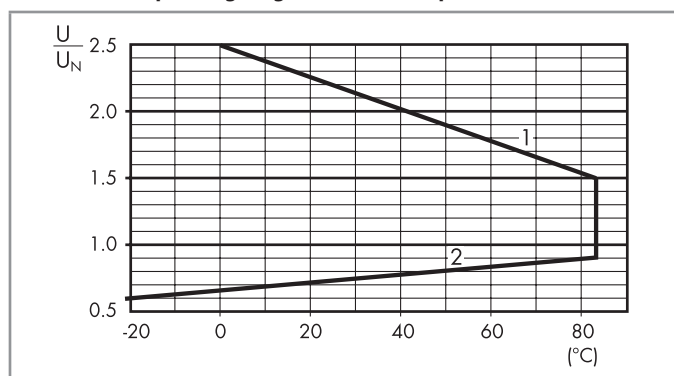

- 1 - Max. permitted coil voltage.
- 2 - Min. pick-up voltage with coil at ambient temperature.

Solid state relay

Technical data

Other data		41.81 - 9024	41.81 - 8240
Power lost to the environment	without current	W 0.25	0.25
	with maximum current	W 1.75	3.5

A

Input specification

Input data - DC types

Nominal voltage U_N	Input code	Operating range		Release voltage	Impedance	Control current I at U_N
		U_{min}	U_{max}			
V		V	V	V	Ω	mA
12	7.012	8	17	4	1550	5.5
24	7.024	14	32	9	2600	9

Output specification

L 41 - Output current v ambient temperature
SSR - 5 A DC output types

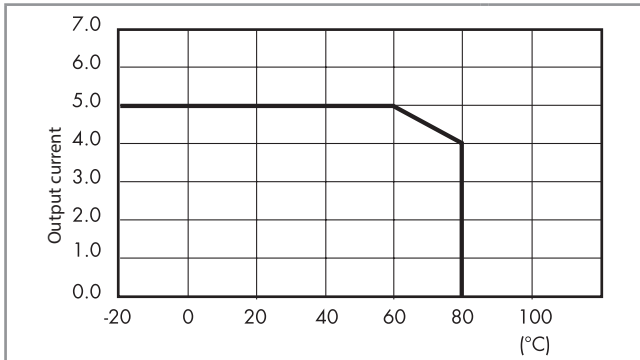

L 41 - Output current v ambient temperature
SSR - 3 A AC output types

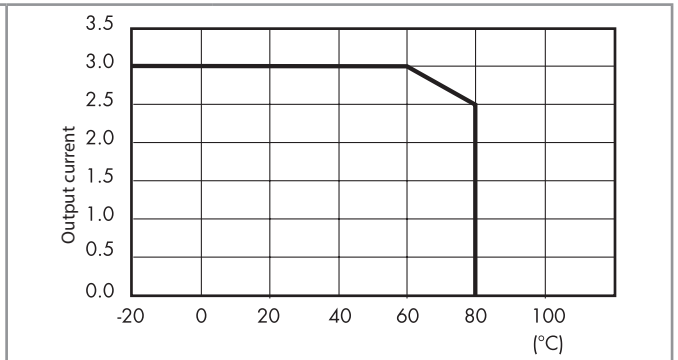

Outline drawings

Types 41.31/52/61

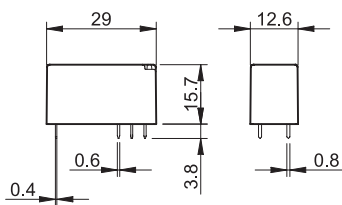

Types 41.52.6.xxx/41.61.6.xxx

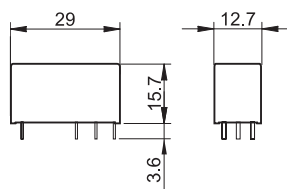

Types 41.81-9024/41.81-8240

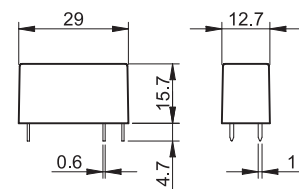

A



93.02

Approvals
(according to type):



Screw terminal socket 35 mm (EN 60715) mounting

Supply voltage	Relay type	Socket type	
6 V AC/DC	41.52.9.005.0010 or 41.61.9.005.0010	93.02.0.024	
12 V AC/DC	41.52.9.012.0010 or 41.61.9.012.0010	93.02.0.024	
24 V AC/DC	41.52/61.9.024.0010 or 41.81.7.024.xxxx	93.02.0.024	
60 V AC/DC	41.52.9.060.0010 or 41.61.9.060.0010	93.02.0.060	
(110...125)V AC/DC	41.52.9.110.0010 or 41.61.9.110.0010	93.02.0.125	
(220...240)V AC/DC	41.52.9.110.0010 or 41.61.9.110.0010	93.02.0.240	
(230...240)V AC	41.52.9.110.0010 or 41.61.9.110.0010	93.02.8.230	
6 V DC	41.52.9.005.0010 or 41.61.9.005.0010	93.02.7.024	
12 V DC	41.52/61.9.012.0010 or 41.81.7.012.xxxx	93.02.7.024	
24 V DC	41.52/61.9.024.0010 or 41.81.7.024.xxxx	93.02.7.024	
48 V DC	41.52.9.048.0010 or 41.61.9.048.0010	93.02.7.060	
60 V DC	41.52.9.060.0010 or 41.61.9.060.0010	93.02.7.060	
Accessories			
8-way jumper link	093.08 (see specification next page)		
Plastic separator	093.01 (see specification next page)		
Sheet of marker tags, 48 tags	060.48 (see specification next page)		
Technical data			
Rated values	10 A - 250 V*		
Dielectric strength	6 kV (1.2/50 μs) between coil and contacts		
Protection category	IP 20		
Ambient temperature (U _N ≤ 60 V / > 60 V)	°C -40...+70/-40...+55		
Screw torque	Nm	0.5	
Wire strip length	mm	8	
Max. wire size for 93.02 socket	solid wire	stranded wire	
	mm ²	1 x 6 / 2 x 2.5	1 x 4 / 2 x 2.5
	AWG	1 x 10 / 2 x 14	1 x 12 / 2 x 14

* For currents > 10 A, contact terminals must be connected in parallel (21 with 11, 24 with 14, 22 with 12).

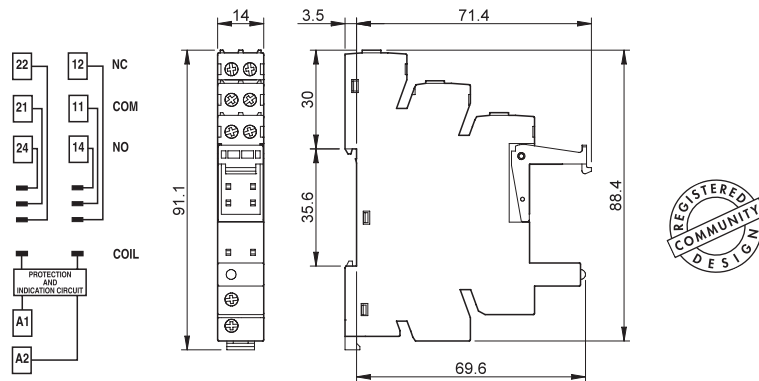

Note: Not for bistable relays

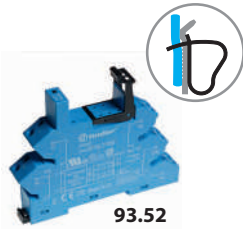

93.52

Approvals
(according to type):

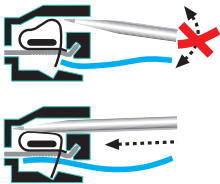
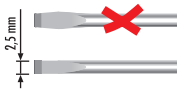

Screwless terminal socket 35 mm (EN 60715) mounting

Supply voltage	Relay type	Socket type
6 V AC/DC	41.52.9.005.0010 or 41.61.9.005.0010	93.52.0.024
12 V AC/DC	41.52.9.012.0010 or 41.61.9.012.0010	93.52.0.024
24 V AC/DC	41.52/61.9.024.0010 or 41.81.7.024.xxxx	93.52.0.024
60 V AC/DC	41.52.9.060.0010 or 41.61.9.060.0010	93.52.0.060
(110...125)V AC/DC	41.52.9.110.0010 or 41.61.9.110.0010	93.52.0.125
(220...240)V AC/DC	41.52.9.110.0010 or 41.61.9.110.0010	93.52.0.240
(230...240)V AC	41.52.9.110.0010 or 41.61.9.110.0010	93.52.8.230
6 V DC	41.52.9.005.0010 or 41.61.9.005.0010	93.52.7.024
12 V DC	41.52/61.9.012.0010 or 41.81.7.012.xxxx	93.52.7.024
24 V DC	41.52/61.9.024.0010 or 41.81.7.024.xxxx	93.52.7.024
48 V DC	41.52.9.048.0010 or 41.61.9.048.0010	93.52.7.060
60 V DC	41.52.9.060.0010 or 41.61.9.060.0010	93.52.7.060

Accessories

8-way jumper link	093.08 (see table below)
Plastic separator	093.01 (see table below)
Sheet of marker tags, 48 tags	060.48 (see table below)

Technical data

Rated values	10 A - 250 V*		
Dielectric strength	6 kV (1.2/50 μs) between coil and contacts		
Protection category	IP 20		
Ambient temperature (U _N ≤ 60 V / > 60 V)	°C	-40...+70/-40...+55	
Wire strip length	mm	8	
Max. wire size for 93.52 socket	solid wire	stranded wire	
	mm ²	1 x 2.5	1 x 2.5
	AWG	1 x 14	1 x 14

* For currents > 10 A, contact terminals must be connected in parallel (21 with 11, 24 with 14, 22 with 12).

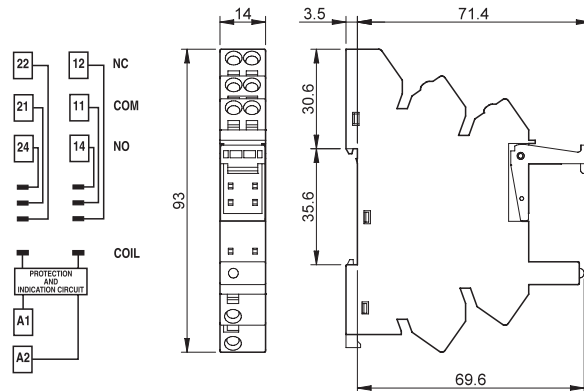

Note: Not for bistable relays

Accessories



093.08

Approvals
(according to type):



8-way jumper link for 93.02 and 93.52 sockets	093.08 (blue)	093.08.0 (black)	093.08.1 (red)
Rated values	10 A - 250 V		

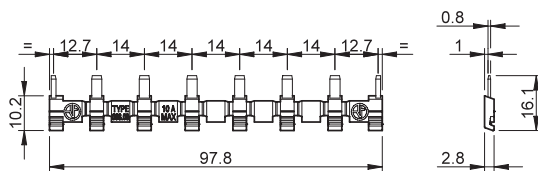

Plastic separator for 93.02 and 93.52 sockets	093.01
--	--------

Thickness 2 mm, required at the start and the end of a group of interfaces.

Can be used for visual separation group, must be used for:

- protective separation of different voltages of neighbouring PLC interfaces according to VDE 0106-101
- protection of cut jumper links

Sheet of marker tags (CEMBRE Thermal transfer printers), plastic, 48 tags, 6 x 12 mm	060.48
---	--------



093.01



060.48

A



95.13.2

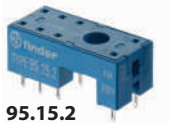

95.15.2

Approvals
(according to type):



PCB socket	95.13.2 (blue)	95.13.20 (black)	95.15.2 (blue)	95.15.20 (black)
For relay type	41.31		41.52, 41.61, 41.81 ⁽¹⁾	
Accessories				
Plastic retaining clip (supplied with socket - packaging code SLA)			095.42.30	
Metal retaining clip			095.41.3	
Technical data				
Rated values	10 A - 250 V*			
Dielectric strength	6 kV (1.2/50 μs) between coil and contacts			
Protection category	IP 20			
Ambient temperature	°C -40...+70			

* For currents > 10 A, contact terminals must be connected in parallel (21 with 11, 24 with 14, 22 with 12).

⁽¹⁾ With the relay 41.81 the NO change-over contact will be 11-14.

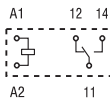

41.31

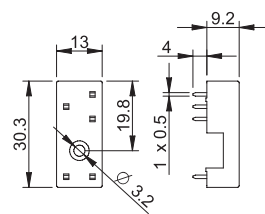

95.13.2
Copper side view

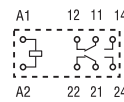

41.52

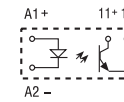

41.81 - 9024

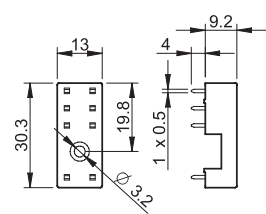

95.15.2
Copper side view

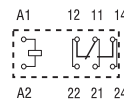

41.61

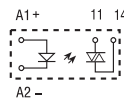

41.81 - 8240

Note: Not for bistable relays

Packaging codes

How to code and identify retaining clip and packaging options for sockets.

Example:



A Standard packaging

SL Plastic retaining clip



Without retaining clip