

## ETD/ETA/ETS SERIES TRI-STATE TYPE

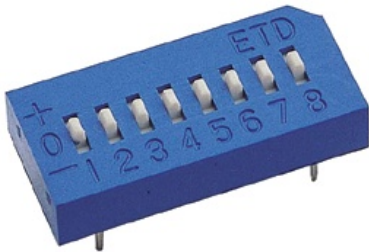

**ETD**



**ETA**

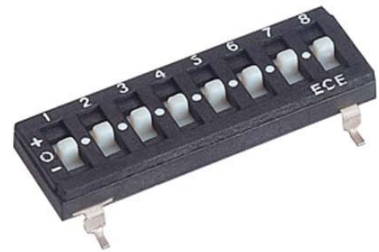

**ETS**

### ■ FEATURES

- With three state (1, open, 0) setting function, especially suitable for encoding/decoding of tri-state encoder/decoder integrated circuit to obtain more security codes than traditional two-state (1,0) operation. For instance, 9 bits with tri-state gets 19,683 ( $3^9$ ) codes, while two-state has 512 ( $2^9$ ) codes, gains 38 times more codes with a ECE tri-state DIP Switch.
- Bottom sealed to ensure free of flux immersion during wave soldering.
- All plastics are UL 94V-0 grade fire retardant.
- Gold plated contact to ensure low contact resistance and Tin plated terminals to prevent contamination during soldering.
- Twin contacts designed to ensure stable contact.
- Ideal for coding tele-communication, transceiving, remote control and burglar alarm systems which use integrated circuits with tri-state coding systems.
- RoHS Compliant

### ■ APPLICATIONS

- Numerical setting for computer terminal equipment
- Price setting for vending machines
- Programming for game machines
- Programming for industrial equipment and measuring instruments

### ■ SPECIFICATIONS

#### 1.ELECTRICAL

● Contact rating	
switching	25mA, 24VDC
non-switching	100mA



● Contact resistance	
initial	50mΩ Max.
after life test	100mΩ Max.
● Insulation resistance	1000MΩ Min. at 100VDC
● Dielectric strength	500VDC Min. for 60 seconds
● Capacitance between adjacent switches 5pF Max.	

**2.MECHANICAL and ENVIRONMENTAL**

● Temperature rating	operating	-40°C to +85°C
	storage	-40°C to +85°C
● Operation force		800g Max.
● Mechanical life		2000 operations
● Humidity		95% RH, 40°C for 96 Hrs.
● Vibration		10Hz-55Hz-10Hz for 6 Hrs.
● Solderability (for through hole type)		After flux 245±5°C for 5±1 seconds
● Resistance to soldering heat		Solder bath:260±5°C for 5±1 seconds. Solder reflow:peak temperature 260°C Max.
● Reflow soldering process for SMT type		Reference IEC61760

## ■ PART NUMBERING SYSTEM

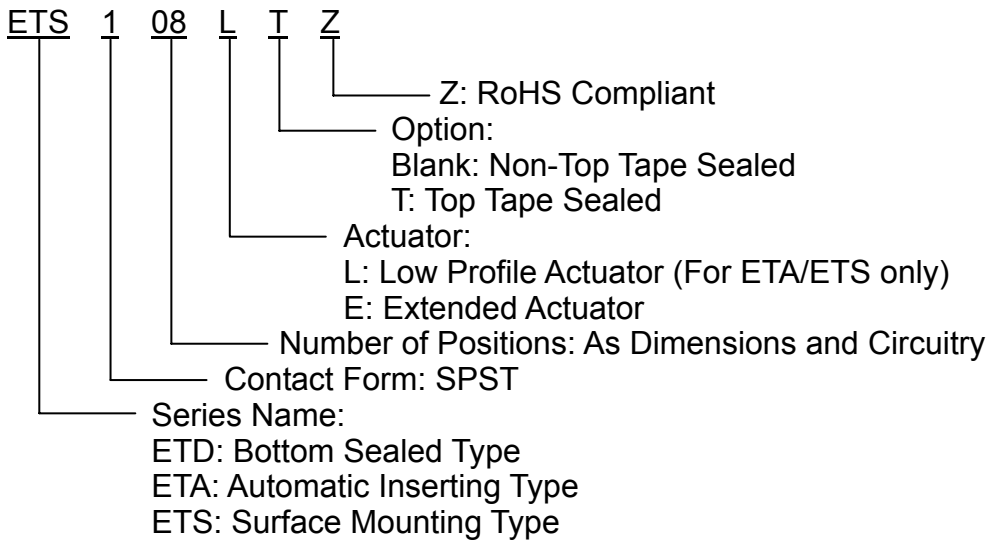

## ■ CONSTRUCTION

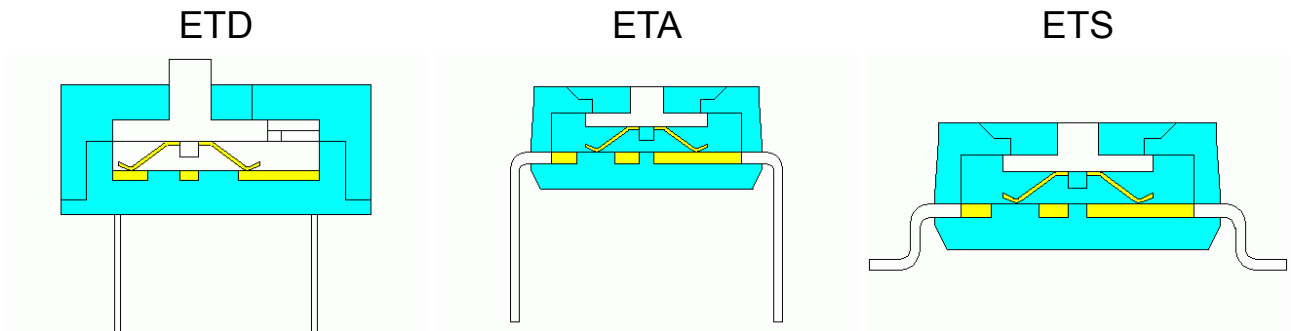

## ■ OPTIONS

1. Tape Sealed

ETDxxxET

ETSxxxLT

ETAxxxLT



2. Reverse P.C.B. LAYOUT available

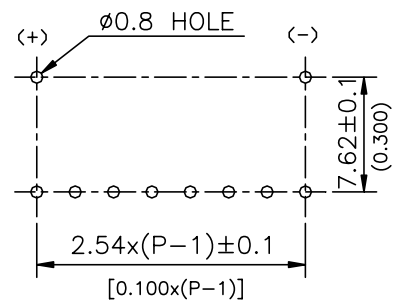

## DIMENSIONS AND CIRCUITRY

### ETD SERIES

Dimension A UNIT:mm(inch)

Positions	4	5	6	7	8	9	10
A	15.30 (0.602)	17.84 (0.702)	20.38 (0.802)	22.92 (0.902)	25.46 (1.002)	28.00 (1.102)	30.54 (1.202)

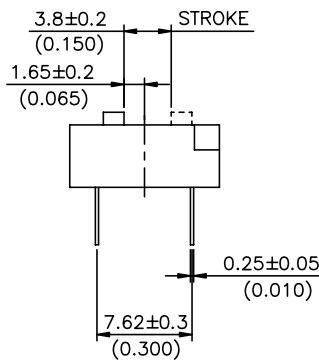
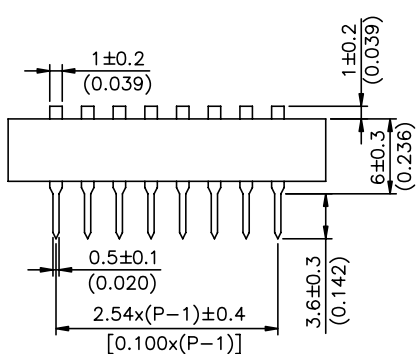
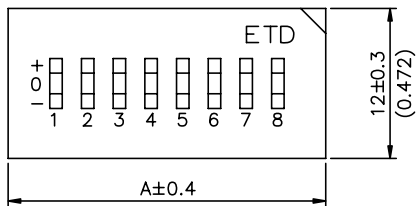

### CIRCUIT DIAGRAM

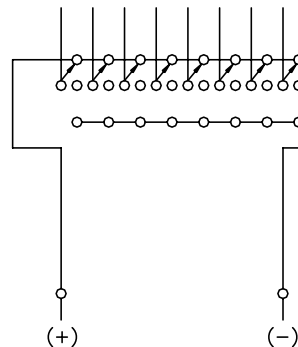

### P.C.B. LAYOUT (TOP VIEW)

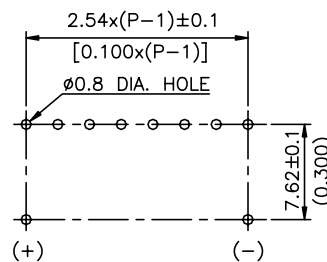

### ETA SERIES

Dimension A UNIT:mm(inch)

Positions	2	3	4	5	6	7	8	9	10	12
A	6.88 (0.263)	9.22 (0.363)	11.76 (0.463)	14.30 (0.563)	16.84 (0.663)	19.38 (0.763)	21.92 (0.863)	24.46 (0.963)	27.00 (1.063)	32.08 (1.263)

\*ETA series: 2, 3 and 6 pole switches are unavailable

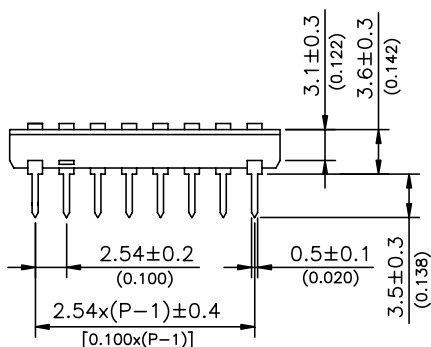
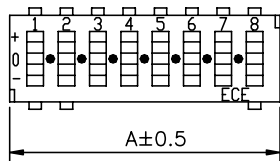

### (L)TYPE

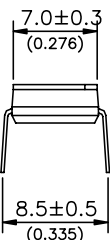

### (E)TYPE

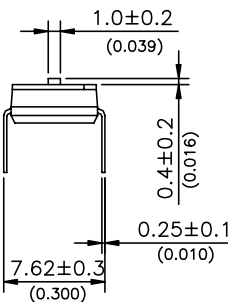

### CIRCUIT DIAGRAM

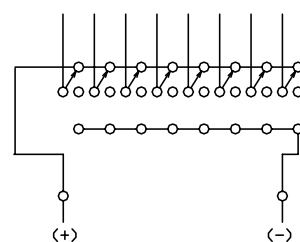

### P.C.B. LAYOUT (TOP VIEW)

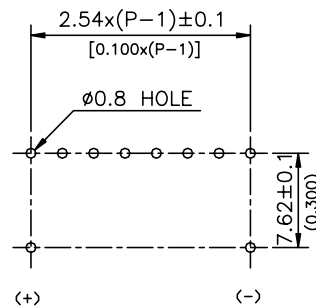

## ETS SERIES

Dimension A

UNIT: mm(inch)

Positions	2	3	4	5	6	7	8	9	10	12
A	6.88 (0.263)	9.22 (0.363)	11.76 (0.463)	14.30 (0.563)	16.84 (0.663)	19.38 (0.763)	21.92 (0.863)	24.46 (0.963)	27.00 (1.063)	32.08 (1.263)

\*ETS series: 2, 3 and 6 pole switches are unavailable

## CIRCUIT DIAGRAM

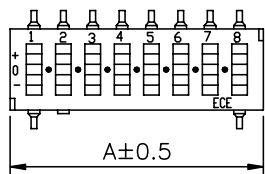
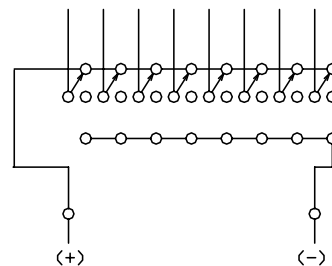

(L)TYPE

(E)TYPE

## P.C.B. LAYOUT (TOP VIEW)

