

WEBSITE PHOTOS

⚠ This dwg is for reference only, Actual dwg should be based on formal engineering dwg issued by Kang Yang.

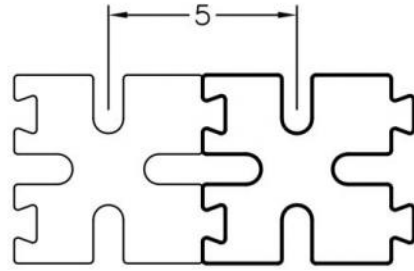
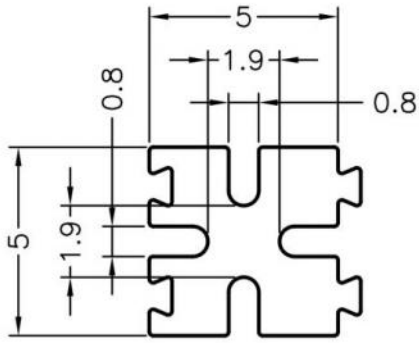

THE PRODUCTS NEED TO COOPERATE CLOSELY WHILE USING.

產品使用時需組合使用

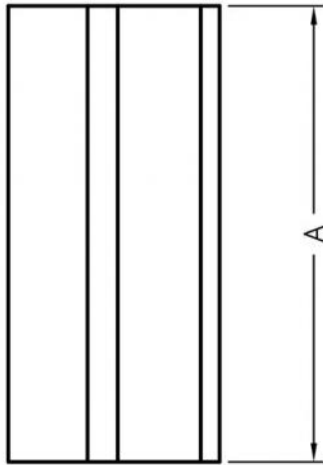

A	P
4.0	1

P	Number of Assembling LED
---	--------------------------

康揚企業股份有限公司
 KANG YANG HARDWARE ENTERPRISE CO., LTD.
康揚塑膠(東莞)有限公司
 KANG YANG PLASTIC(DONG GUAN)CO.,LTD.
康哲電腦配件(吳江)有限公司
 KANG CHE COMPUTER COMPONENTS(WUJIANG) CO.,LTD.

PART NUMBER		LEDP-4		SPEC. DWG.	
TITLE					
LED SPACER SUPPORT					
MATERIAL			COLOR		
NYLON 66(UL) 94V-2			BLACK		
SIZE	SCALE	UNIT	CHECK		
A4	2:1	mm	Z.C		