

MUR16XXCT Series

Dual Ultrafast Plastic Rectifier

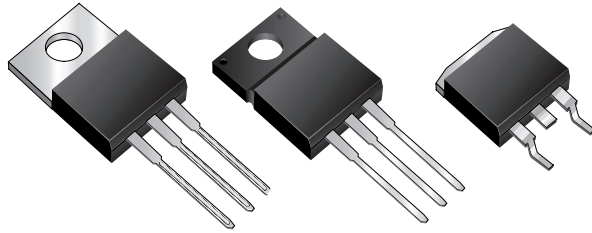

Reverse Voltage 50 to 600V
 Forward Current 16A
 Reverse Recovery Time 35 to 50ns

TO-220AB (FEP16JT Series)

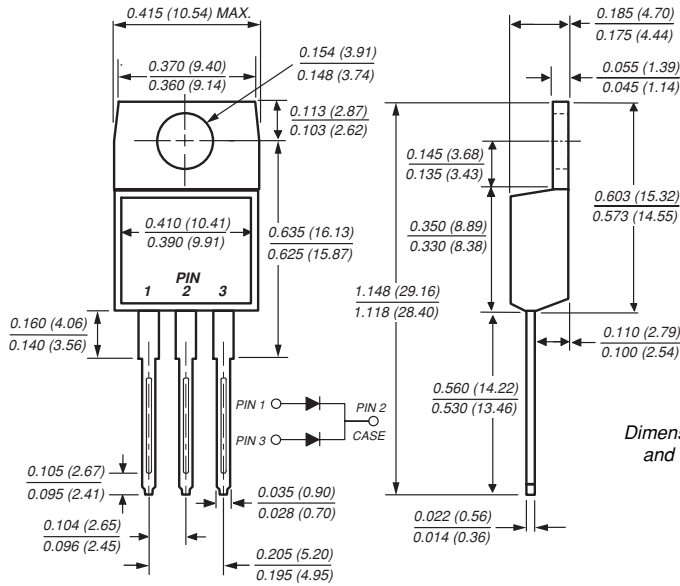

Mounting Pad Layout TO-263AB

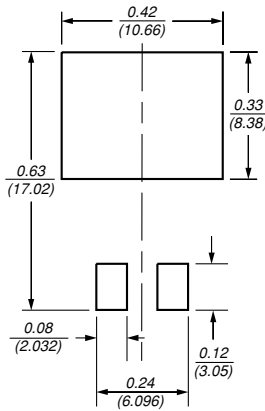

ITO-220AB (FEPF16JT Series)

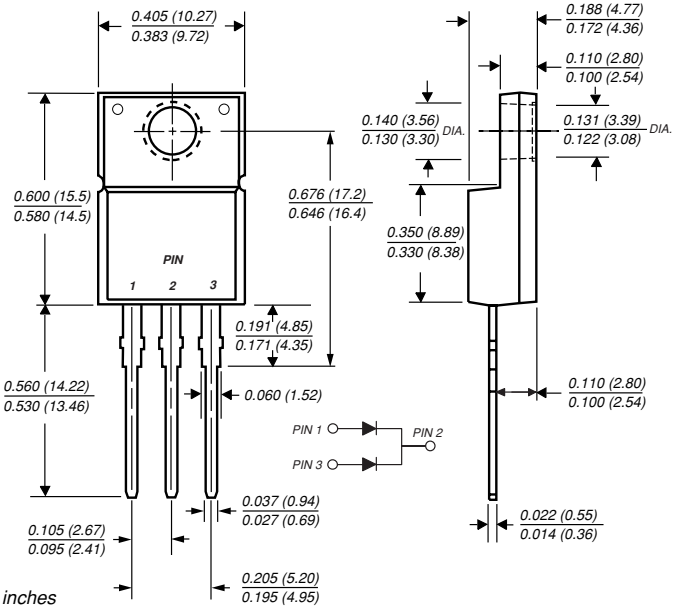

Dimensions in inches and (millimeters)

TO-263AB (FEPB16JT Series)

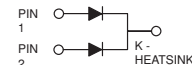
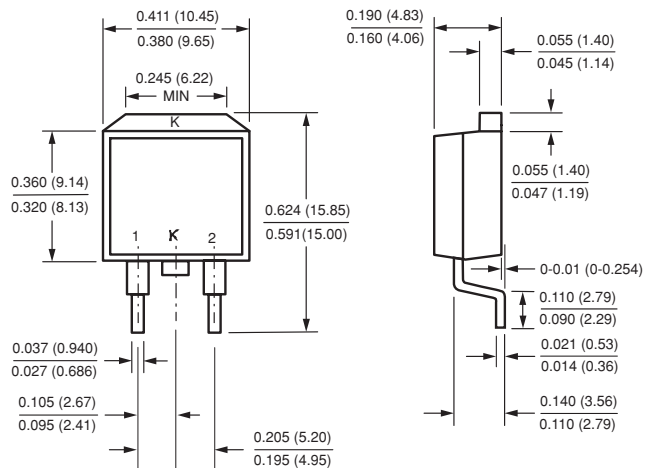

Features

- Plastic package has Underwriters Laboratory Flammability Classification 94V-0
- Dual rectifier construction, positive centertap
- Glass passivated chip junction
- Low power loss
- High surge current capability
- Low forward voltage, high current capability
- Superfast recovery times for high efficiency

Mechanical Data

Case: JEDEC TO-220AB, ITO-220AB & TO-263AB molded plastic body

Terminals: Plated leads, solderable per MIL-STD-750, Method 2026

High temperature soldering guaranteed: 250°C/10 seconds at terminals

Polarity: As marked **Mounting Position:** Any

Mounting Torque: 10 in-lbs maximum

Weight: 0.08 oz., 2.24 g

Maximum Ratings Ratings at 25°C ambient temperature unless otherwise specified.

Parameter	Symbol	MUR 1605	MUR 1610	MUR 1615	MUR 1620	MUR 1630	MUR 1640	MUR 1645	MUR 1660	Unit
Maximum repetitive peak reverse voltage	V _{RRM}	50	100	150	200	300	400	450	600	V
Maximum RMS voltage	V _{RMS}	35	70	105	140	210	280	350	420	V
Maximum DC blocking voltage	V _{DC}	50	100	150	200	300	400	500	600	V
Maximum average forward rectified current at T _C = 100°C	I _{F(AV)}	16								A
Peak forward surge current 8.3 ms single half sine-wave superimposed on rated load (JEDEC Method) at T _C = 100°C per leg	I _{FSM}	200				125				A
Operating storage and temperature range	T _J , T _{STG}	-55 to +150								°C
RMS Isolation voltage (FEPF) from terminals to heatsink with t = 1.0 second, RH ≤ 30%	V _{ISOL}	4500 ⁽¹⁾ 3500 ⁽²⁾ 1500 ⁽³⁾								V

Electrical Characteristics Ratings at 25°C ambient temperature unless otherwise specified.

Parameter	Symbol	MUR 1605	MUR 1610	MUR 1615	MUR 1620	MUR 1630	MUR 1640	MUR 1645	MUR 1660	Unit	
Maximum instantaneous forward voltage per leg at 8.0A	V _F	0.98			1.30		1.60			V	
Maximum DC reverse current per leg at rated DC blocking voltage T _C = 25°C T _C = 100°C	I _R	10 500									μA
Maximum reverse recovery time per leg at I _F = 0.5A, I _R = 1.0A, I _{rr} = 0.25A	t _{rr}	35				60				ns	
Typical junction capacitance per leg at 4V, 1MHz	C _J	85						50		pF	

Ratings and Characteristic Curves ($T_A = 25^\circ\text{C}$ unless otherwise noted)

Fig. 1 – Forward Current Derating Curve

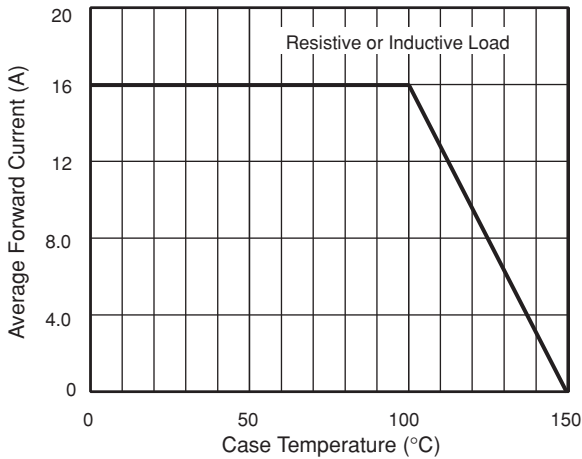

Fig. 2 – Maximum Non-Repetitive Peak Forward Surge Current

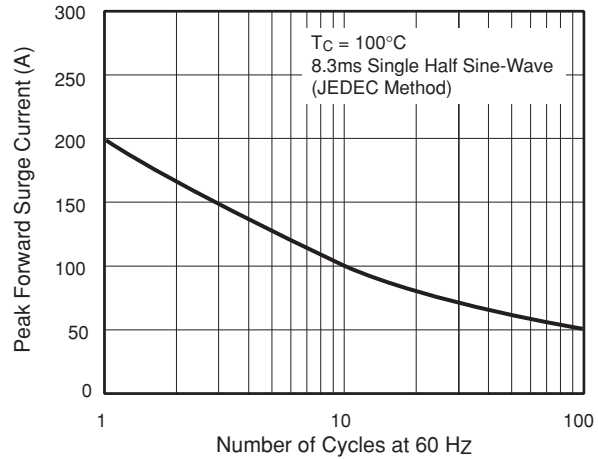

Fig. 3 – Typical Instantaneous Forward Characteristics Per Leg

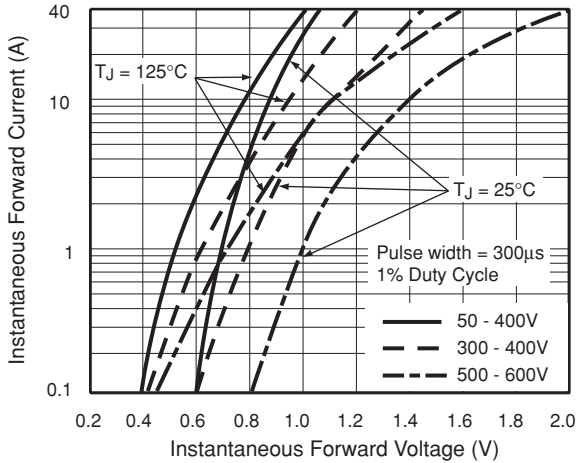

Fig. 4 – Typical Reverse Characteristics Per Leg

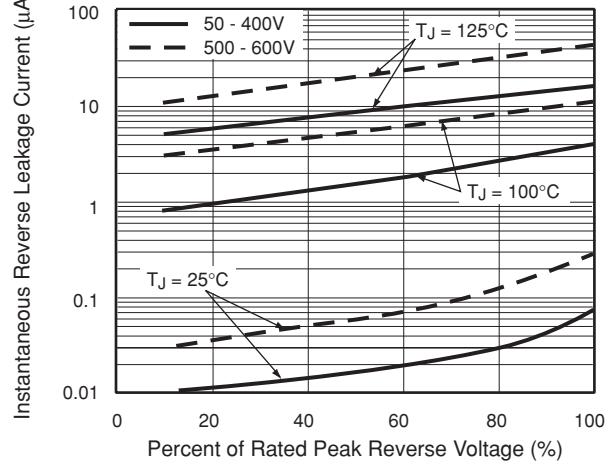

Fig. 5 – Typical Junction Capacitance Per Leg

