

# RC series Thick Film Chip Resistor

## ◆ Features

- » Small size and light weight
- » Compatible with wave and reflow soldering
- » Suitable for lead free soldering
- » RoHS compliant & Halogen Free

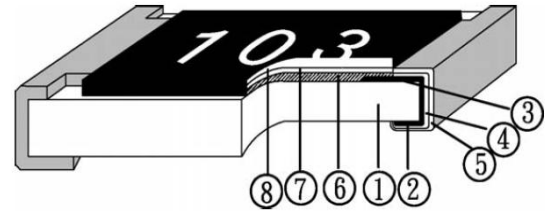

## ◆ Applications

- » Consumer Electronics
- » Measurement instrument
- » Computer

## ◆ Configuration

1	Alumina Substrate	5	External Electrode
2	Bottom Electrode	6	Resistor Layer
3	Top Electrode	7	Primary Overcoat
4	Barrier Layer	8	Secondary Overcoat

## ◆ Dimension

Unit: mm

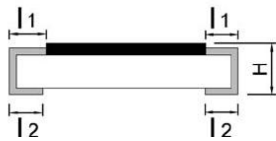
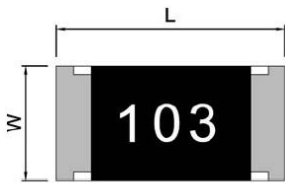

RC0201 / RC0402 / RC0603 / RC0805 / RC1206  
RC1210 / RC1812 / RC2010 / RC2512

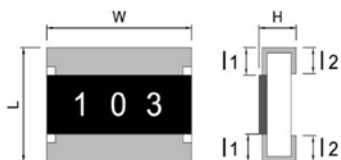

RC1218 / RC2030/RC0612

TYPE	L	W	H	l1	l2
RC0201	0.60±0.03	0.30±0.03	0.23±0.03	0.12±0.05	0.15±0.05
RC0402	1.00±0.10	0.50±0.05	0.30±0.05	0.20±0.10	0.25±0.10
RC0603	1.60±0.10	0.80±0.10	0.45±0.10	0.30±0.15	0.30±0.15
RC0805	2.00±0.10	1.25±0.10	0.50±0.10	0.35±0.20	0.35±0.15
RC1206	3.05±0.10	1.55±0.10	0.55±0.15	0.45±0.20	0.35±0.15
RC1210	3.05±0.10	2.55±0.10	0.55±0.10	0.50±0.20	0.50±0.20
RC1812	4.50±0.10	3.00±0.10	0.55±0.05	0.55±0.20	0.70±0.20
RC2010	5.00±0.20	2.50±0.20	0.55±0.10	0.60±0.20	0.60±0.20
RC1218	3.10±0.10	4.60±0.10	0.55±0.05	0.40±0.20	0.50±0.20
RC2512	6.40±0.20	3.20±0.20	0.60±0.15	0.60±0.25	0.90±0.25
RC2030	5.10±0.10	7.60±0.10	0.60±0.05	0.80±0.20	0.80±0.20
RC0612	1.60±0.20	3.20±0.20	0.55±0.10	0.30±0.20	0.50±0.20

## ◆ Power Derating Curve

»Type

RC0201

RC0402 / RC0603 / RC0805 / RC1206 / RC1210  
RC1812 / RC2010 / RC1218 / RC2512 / RC2030  
RC0612

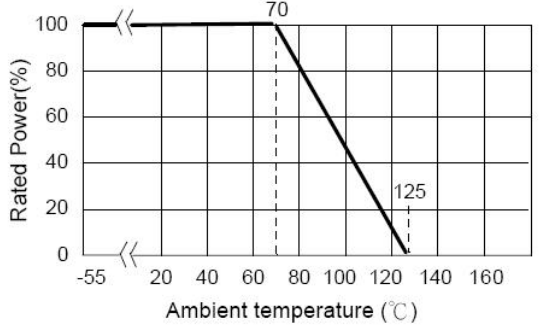
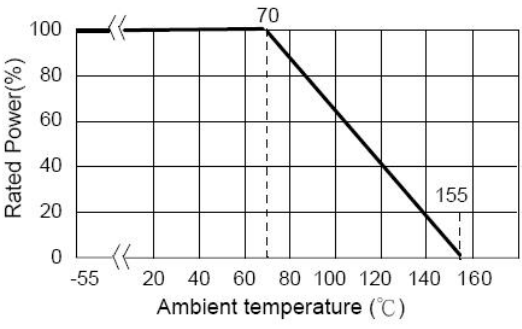
Operating Temperature Range	-55°C ~ +125°C	-55°C ~ +155°C
Explain	For resistors operated in ambient temperatures above 70°C, power rating shall be derated in accordance with figure below.	For resistors operated in ambient temperatures above 70°C, power rating shall be derated in accordance with figure below.
Figure		

## ◆ Voltage Rating or Current Rating Resistance

Range:  $\geq 1\Omega$

**Rated Voltage:** The resistor shall have a DC continuous working voltage or a RMS AC continuous working voltage at commercial-line frequency and wave form corresponding to the power rating, as determined formula as following:

$$E = \sqrt{P \times R}$$

**E=Rated voltage (V)**  
**P=Power rating (W)**  
**R=Nominal resistance( $\Omega$ )**

## ◆ Soldering Profile

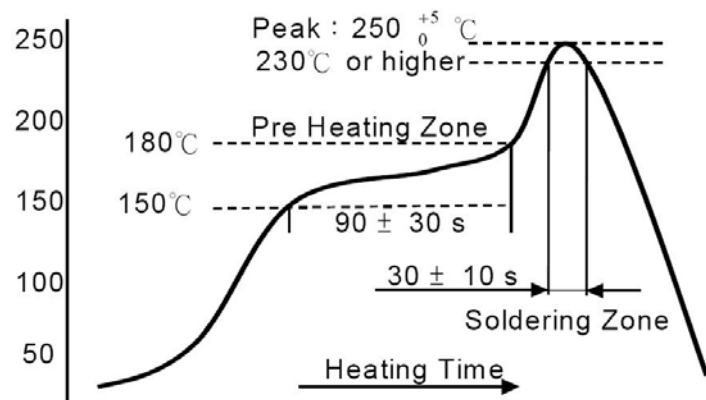

## ◆ Rating

TYPE	Power Rating At 70°C (W)	Max Working Voltage	Max Overload Voltage	TCR (ppm/°C) Lower available	Resistance Range	
					1%	5%
RC0201	1/20 W (0.05 W)	25V	50V	-100~+350	$1\Omega \leq R < 10\Omega$	$1\Omega \leq R < 10\Omega$
				±200	$10\Omega \leq R \leq 10M\Omega$	$10\Omega \leq R \leq 10M\Omega$
RC0402	1/16 W (0.063 W)	50V	100V	0~+400	$1\Omega \leq R < 10\Omega$	$1\Omega \leq R < 10\Omega$
				±200	---	$10\Omega \leq R < 10M\Omega$
				±100	$10\Omega \leq R \leq 10M\Omega$	---
				±400	$1\Omega \leq R < 10\Omega$	$1\Omega \leq R < 10\Omega$
RC0603	1/10 W (0.1 W)	75V	100V	±200	---	$10\Omega \leq R \leq 10M\Omega$
				±100	$10\Omega \leq R \leq 10M\Omega$	---
RC0805	1/8 W (0.125 W)	150V	300V	±400	$1\Omega \leq R < 10\Omega$	$1\Omega \leq R < 10\Omega$
				±200	---	$10\Omega \leq R \leq 10M\Omega$
				±100	$10\Omega \leq R \leq 10M\Omega$	---
				±400	$1\Omega \leq R < 10\Omega$	$1\Omega \leq R < 10\Omega$
RC1206	1/4 W (0.25 W)	200V	400V	±200	---	$10\Omega \leq R \leq 10M\Omega$
				±100	$10\Omega \leq R \leq 10M\Omega$	---
RC1210	1/2 W (0.5 W)	200V	400V	±400	$1\Omega \leq R < 10\Omega$	$1\Omega \leq R < 10\Omega$
				±200	---	$10\Omega \leq R \leq 10M\Omega$
				±100	$10\Omega \leq R \leq 10M\Omega$	---
				±400	$1\Omega \leq R < 10\Omega$	$1\Omega \leq R < 10\Omega$
RC1812	3/4 W (0.75 W)	200V	400V	±200	---	$10\Omega \leq R \leq 10M\Omega$
				±100	$10\Omega \leq R \leq 10M\Omega$	---
RC2010	3/4 W (0.75 W)	200V	400V	±400	$1\Omega \leq R < 10\Omega$	$1\Omega \leq R < 10\Omega$
				±200	---	$10\Omega \leq R \leq 10M\Omega$
				±100	$10\Omega \leq R \leq 10M\Omega$	---
				±400	$1\Omega \leq R < 10\Omega$	$1\Omega \leq R < 10\Omega$
RC1218	1 W	200V	400V	±200	---	$10\Omega \leq R \leq 10M\Omega$
RC0612	0.75W			±100	$10\Omega \leq R \leq 10M\Omega$	---
RC2512	1W	200V	400V	±400	$1\Omega \leq R < 10\Omega$	$1\Omega \leq R < 10\Omega$
				±200	---	$10\Omega \leq R \leq 10M\Omega$
				±100	$10\Omega \leq R \leq 10M\Omega$	---
				±400	$1\Omega \leq R < 10\Omega$	$1\Omega \leq R < 10\Omega$
RC2030	2W	200V	400V	±200	---	$10\Omega \leq R < 10K\Omega$
				±100	$10\Omega \leq R < 10K\Omega$	---

TYPE	0201	0402	0603	0805	1206	1210	1812	2010	2512
Jumper Rated Current	0.5A	1A		2A					

TYPE	0612	1218	2030
Jumper Rated Current	4A	6A	10A

Note: Lower TCR is available for customer's requirement.

### ◆ Part Number

RC	0603	J	100K	□	□□
Type	Size	Tolerance	R VALUE	Reel Size	Package quantity
RC	0201	J=5%	1Ω= 1R	Blank = 7"	(Standard Package As below)
	0402	F=1%	10KΩ= 10K	B= 13"	10 = 10K per reel
	0603		2.2MΩ=2M2	C= 10"	20 = 20K per reel
	0805				08= 8K per reel
	1206				16= 16K per reel
	1210				
	1218				
	2512				
	2030				
	0612				

» Standard Package Q'ty for each size is as following.

TYPE	Standard Package Q'ty
RC0201	10K per reel
RC0402	10K per reel
RC0603	5K per reel
RC0805	5K per reel
RC1206	5K per reel
RC1210	5K per reel
RC1812	4K per reel
RC2010	4K per reel
RC1218	4K per reel
RC2512	4K per reel
RC2030	1K per reel
RC0612	5K per reel

## ◆ Specification

### Specification and Test Methods

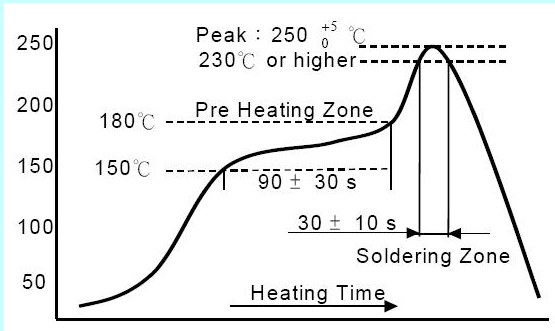
TEST ITEM	TEST METHOD	SPECIFICATON	REQUIREMENTS
Temperature Coefficient of Resistance (T.C.R)	JIS C 5201-1 clause 4.8	-55°C ~+155°C, 20°C is the reference temperature	Refer to Ratings
Short Time Overload	JIS C 5201-1 clause 4.13	General : 2.5 times RCWV or Max. Overload voltage for 5 seconds. High Power : 2.5 times RCWV or Max. Overload voltage for 2 seconds.	±1% : ±(1.0%+0.05Ω) ±5% : ±(2.0%+0.1Ω)
IR Reflow	Sony SS-00254	 <p>The graph shows a temperature profile for IR reflow. The y-axis is temperature in °C (50 to 250) and the x-axis is Heating Time. Key points include: a peak of 250°C (with a tolerance of +5°C) and a minimum of 230°C or higher; a pre-heating zone at 180°C; a heating time of 90 ± 30 s to reach the peak; and a soldering zone of 30 ± 10 s at the peak.</p>	±1% : ±(1.0%+0.05Ω) ±5% : ±(1.0%+0.05Ω)
Leaching	Sony SS-00254-9	260±5°C for 30 seconds.	>95% Coverage
Soldering Heat	JIS C 5201-1 clause 4.18	260±5°C for 10 seconds.	±1% : ±(0.5%+0.05Ω) ±5% : ±(1.0%+0.05Ω)
Temperature Cycling	JIS C 5201-1 clause 4.19	-55°C to +155°C, 5 cycles	±1% : ±(0.5%+0.05Ω) ±5% : ±(1.0%+0.10Ω)
Electric Iron	Sony SS-00254-5	Preheating temperature : 350±10°C Electric iron preheating time : 3+1/-0 sec	±1% : ±(1.0%+0.05Ω) ±5% : ±(1.0%+0.05Ω)
Resistance to Solvent	JIS C 5201-1 clause 4.29	The tested resistor be immersed into isopropyl alcohol of 20~25°C for 60 secs. Then the resistor is left in the room for 48 hrs.	±1% : ±(0.5%+0.05Ω) ±5% : ±(0.5%+0.05Ω)
Load Life in Humidity	JIS C 5201-1 clause 4.24	40±2°C, 90~95% R.H. or Max. working voltage for 1000 hrs with 1.5 hrs "ON" and 0.5 hr "OFF" .	±1% : ±(0.5%+0.05Ω) ±5% : ±(2.0%+0.05Ω)
Load Life (Endurance)	JIS C 5201-1 clause 4.25	70±2°C, or Max. working voltage for 1000 hrs with 1.5 hrs "ON" and 0.5 hr "OFF" .	±1% : ±(1.0%+0.05Ω) ±5% : ±(3.0%+0.10Ω)
Terminal Bending Strength	JIS C 5201-1 clause 4.33	Bending once for 5 seconds D : 0402、0603、0805=5mm 1206、1210、1812=3mm 0612、1218、2010、2512、2030=2mm	±1% : ±(1.0%+0.05Ω) ±5% : ±(1.0%+0.05Ω)
Insulation Resistance	JIS C 5201-1 clause 4.6	Max. Overload voltage for 1 minute.	≥ 10GΩ

## ◆ Packing

### Tape Dimension

#### » Paper Carrier

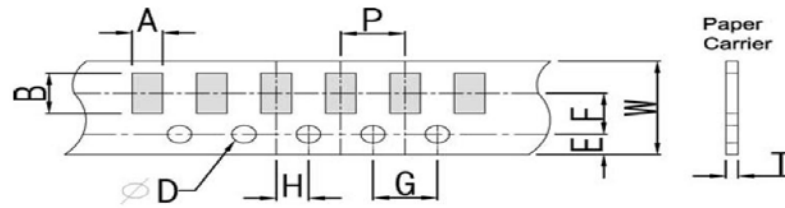

Unit: mm

TYPE	A	B	W	E	F	G	H	T	$\phi D$	P
RC0201	0.45± 0.1	0.75± 0.1	8.0± 0.2	1.75± 0.1	3.5± 0.05	4.0± 0.1	2.0± 0.05	0.35± 0.1	1.5± 0.1	2.0± 0.1
RC0402	0.70± 0.1	1.20± 0.1	8.0± 0.2	1.75± 0.1	3.5± 0.05	4.0± 0.1	2.0± 0.05	0.45± 0.1	1.5± 0.1	2.0± 0.1
RC0603	1.05± 0.2	1.80± 0.2	8.0± 0.2	1.75± 0.1	3.5± 0.05	4.0± 0.1	2.0± 0.05	0.60± 0.1	1.5± 0.1	4.0± 0.1
RC0805	1.55± 0.2	2.30± 0.2	8.0± 0.2	1.75± 0.1	3.5± 0.05	4.0± 0.1	2.0± 0.05	0.75± 0.1	1.5± 0.1	4.0± 0.1
RC1206 RC0612	1.90± 0.2	3.50± 0.2	8.0± 0.2	1.75± 0.1	3.5± 0.05	4.0± 0.1	2.0± 0.05	0.75± 0.1	1.5± 0.1	4.0± 0.1
RC1210	2.80± 0.2	3.50± 0.2	8.0± 0.2	1.75± 0.1	3.5± 0.05	4.0± 0.1	2.0± 0.05	0.75± 0.1	1.5± 0.1	4.0± 0.1

#### » Embossed Carrier

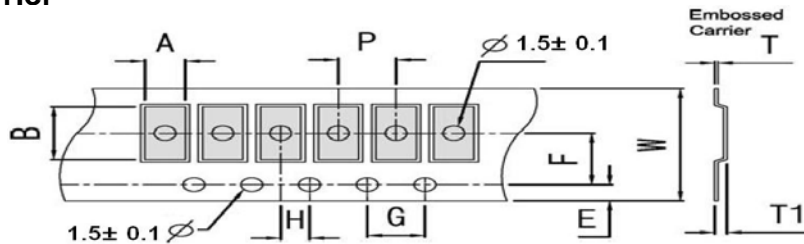

Unit: mm

TYPE	A	B	W	E	F	G	H	T	T1	P
RC1812	3.30± 0.2	4.60± 0.2	12.0± 0.2	1.75± 0.1	5.5± 0.05	4.0± 1	2.0± 0.05	0.23± 0.1	0.85± 0.15	4.0± 0.1
RC2010	2.80± 0.2	5.60± 0.2	12.0± 0.2	1.75± 0.1	5.5± 0.05	4.0± 1	2.0± 0.05	0.23± 0.1	0.85± 0.15	4.0± 0.1
RC1218	3.30± 0.2	4.60± 0.2	12.0± 0.2	1.75± 0.1	5.5± 0.05	4.0± 1	2.0± 0.05	0.23± 0.1	0.85± 0.15	4.0± 0.1
RC2512	3.40± 0.2	6.70± 0.2	12.0± 0.2	1.75± 0.1	5.5± 0.05	4.0± 1	2.0± 0.05	0.23± 0.1	0.85± 0.15	4.0± 0.1
RC2030	5.50± 0.2	7.90± 0.2	16.0± 0.2	1.75± 0.1	7.5± 0.05	4.0± 1	2.0± 0.05	0.25± 0.1	0.85± 0.15	8.0± 0.2

### Lead Dimensions

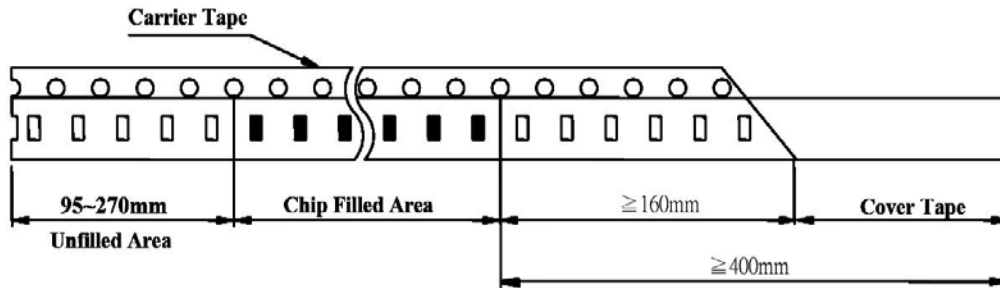

Top Adhesive Peel Off Strength : 10~70g

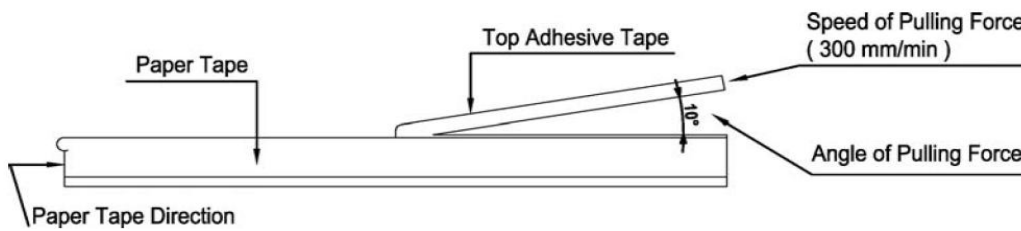

**◆ Packing**  
**Reel Dimensions**

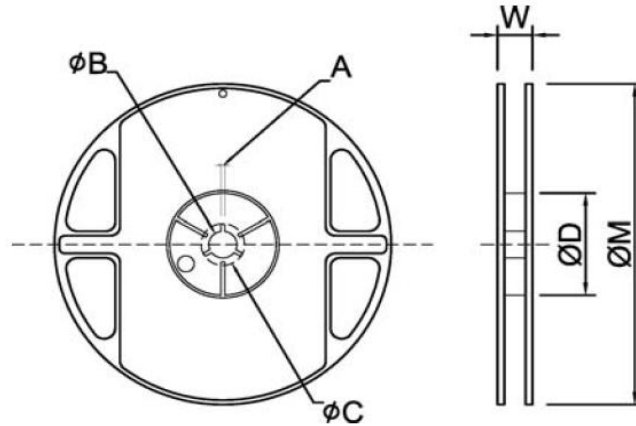

Unit: mm

TYPE	SIZE		A	$\phi B$	$\phi C$	$\phi D$	W	$\phi M$
RC0201	7"	15K/Reel	2.0±0.5	13.5±1.0	21±1.0	60±1.0	11.5±2.0	178±2.0
RC0402	7"	10K/Reel	2.0±0.5	13.5±1.0	21±1.0	60±1.0	11.5±2.0	178±2.0
	13"	30K/Reel	2.0±0.5	13.5±1.0	21±1.0	100±1.0	11.5±2.0	330±2.0
RC0603	7"	5K/Reel	2.0±0.5	13.5±1.0	21±1.0	60±1.0	11.5±2.0	178±2.0
RC0612	10"	10K/Reel	2.0±0.5	13.5±1.0	21±1.0	100±1.0	11.5±2.0	254±2.0
RC0805		10K/Reel	2.0±0.5	13.5±1.0	21±1.0	100±1.0	11.5±2.0	254±2.0
RC1206	13"	20K/Reel	2.0±0.5	13.5±1.0	21±1.0	100±1.0	11.5±2.0	330±2.0
RC1210		20K/Reel	2.0±0.5	13.5±1.0	21±1.0	100±1.0	11.5±2.0	330±2.0
RC1812	7"	4K/Reel	2.0±0.5	13.5±1.0	21±1.0	60±1.0	16.0±2.0	178±2.0
RC2010		4K/Reel	2.0±0.5	13.5±1.0	21±1.0	60±1.0	16.0±2.0	178±2.0
RC1218		4K/Reel	2.0±0.5	13.5±1.0	21±1.0	60±1.0	16.0±2.0	178±2.0
RC2512		4K/Reel	2.0±0.5	13.5±1.0	21±1.0	60±1.0	16.0±2.0	178±2.0
RC2030	7"	1K/Reel	2.0±0.5	13.5±1.0	21±1.0	60±1.0	19.0±2.0	178±2.0