

souriau connectors **DSub**

*Contains
Notes from European
trips.*



SOURIAU

contents

□ Connectors

- Connector selection guide	4
- All purpose D-sub connectors	series D and DP . 6
- Industrial crimp D-sub connectors	series 8634 . 8
- Insulation displacement D-sub connectors	series 8657/8658 . 10
- High spec D-sub connectors	series DM Mk 1 . 12
- Power and coaxial D-sub connectors	series DMW . 14
- High spec removable crimp D-subconnectors	series 8630 Mk 3 . 16
- High density D-sub connectors	series 8635 . 18
- Non-magnetic D-sub connectors	series DM/8630-DM . 20
- Filter D-sub connectors	series DJ . 22
- Hermetic D-sub connectors	series DH . 24

□ Accessories

- Plastic hoods	26
- EMI/RFI shielded hoods	28
- Metal hoods	28
- Screw locks	29
- Lever locks	30
- Slide locks	30
- Quick release locks	30
- Dust caps	30
- Gender/RS 232/IEEE 488 interfaces	31

□ Connector reference information

- Panel mounting	31
- Shell dimensions all series (excluding DH - see pages 24 and 25)	32
- P.C. card drilling dimensions	32
- Panel cutouts (all series)	33
- Mounting brackets for angled shell connectors	34
- Souriau/MIL-C-24308 cross reference list	35

souriau D-Sub connector guide

Hybrid Power and Coaxial contact version of higher specification DM series featuring a wide range of layouts and contact styles

Higher specification crimp D-sub connector meeting worldwide military and related application requirements. MIL-C-24308A

High density, machined contact crimp connector, widely used in international military projects

Non-magnetic series designed primarily for use in space and other applications requiring very high reliability and immunity to magnetic influences

Filter connectors for use in aerospace, military and increasingly in computer applications requiring protection from EMI/RFI interference

Hermetic D-sub connector series for use on equipment requiring "low leakage" characteristics

MW	8630	8635	DM/8630NM	DJ	DH
cadmium plated steel passivated	cadmium plated steel passivated	cadmium plated steel passivated	cadmium or gold plated copper alloy	tin plated copper alloy or steel	cadmium plated steel passivated or tin plated
thermoset self-extinguishing	thermoset self-extinguishing	thermoset self-extinguishing	thermoset self-extinguishing	thermoset self-extinguishing	glass
copper alloy	copper alloy	copper alloy	copper alloy	copper alloy	ferrous alloy
gold over nickel	gold over nickel	gold over nickel	gold over copper	gold	gold over nickel
gold over nickel	gold over nickel	gold over nickel	gold over copper	gold	nickel + tin or gold over nickel
coax contacts - core-solder bucket - screen-solder bucket power contacts - solder bucket standard contacts - as DP series	crimp	crimp	- solder bucket (DM-NM) - straight spill (DM-NM) - angled spill (DM-NM) - crimp (8630-NM)	- solder bucket - straight spill - angled spill	- solder bucket - straight spill
coax/power contacts only	yes	yes	no (DM-NM), yes (8630-NM)	no	no
1mm (standard cts.)	1mm	0.76mm	1mm	1mm	1mm
AWG (standard cts.) others see page 15	AWG 20 max.	AWG 22 max.	AWG 20 max.	AWG 20 max.	AWG 20 max.
2.1mm	1.7mm	1.37mm	2.1mm (DM-NM) 1.7mm (8630-NM)	2.1mm	2.1mm
1000V (800V angled)	1000V	1000V	1000V	see page 20	750V
300V	300V	300V	300V	see page 20	—
300V (standard cts.)	300V	300V	300V	see page 20	—
7.5A (standard cts.) 40A (power cts.)	7.5A	5A	7.5A	5A	7.5A
≥ 5000 MΩ	≥ 5000 MΩ	≥ 5000 MΩ	≥ 5000 MΩ	≥ 5000 MΩ	≥ 5000 MΩ
≤ 7.3 mΩ	≤ 7.3 mΩ	≤ 14.6 mΩ	≤ 5 mΩ	≤ 5 mΩ	≤ 14 mΩ
-56°C to +125°C	-55°C to +150°C	-55°C to +150°C	55°C to +150°C	-66°C to +125°C	-55°C to +125°C peak +750°C (1min)
	QPL approved	conforms	Class N QPL approved		conforms
	CCQ approved				
14-15	16-17	18-19	20-21	22-23	24-25

all purpose D-sub connectors (D & DP series)

layouts male insulator front view

contacts are individually numbered on both sides of the insulator

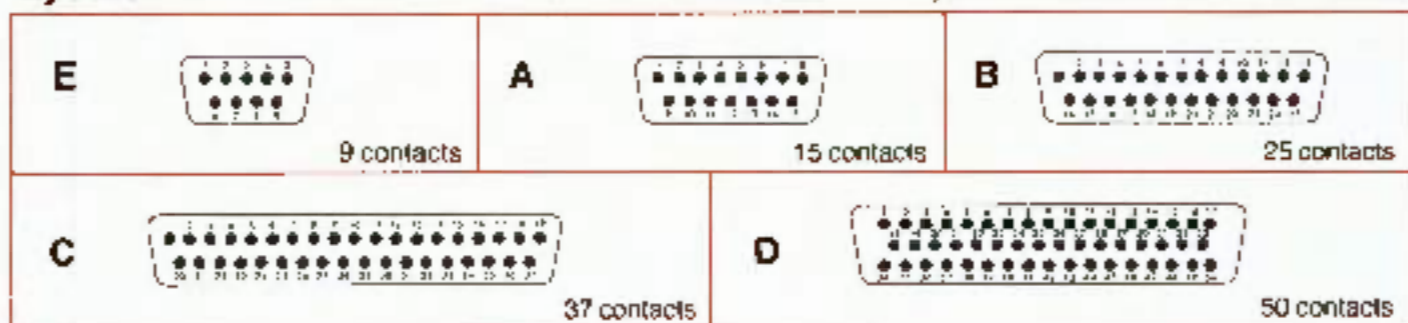

Ordering information

shell size	series	male or	solder bucket	straight spill	wire wrap		angled spill with riveted brackets	
					⊙ wrap	⊙ wrap	3.0mm pitch between rows	3.0mm pitch between rows
E 9 cts	D	P	DE D9P064	DE D9P364	DE D9P431	DE D9P631	DE D9P564	DE D9P864
		S	DE D9S064	DE D9S364	DE D9S431	DE D9S631	DE D9S564	DE D9S864
	DP	P	DEP09P	DEP09P300	DEP09P400	DEP09P500	DEP09P500	DEP09P800
		S	DEP09S	DEP09S300	DEP09S400	DEP09S600	DEP09S500	DEP09S800
A 15 cts	D	P	DA 15P064	DA 15P364	DA 15P431	DA 15P631	DA 15P564	DA 15P864
		S	DA 15S064	DA 15S364	DA 15S431	DA 15S631	DA 15S564	DA 15S864
	DP	P	DAP15P	DAP15P300	DAP15P400	DAP15P500	DAP15P500	DAP15P800
		S	DAP15S	DAP15S300	DAP15S400	DAP15S800	DAP15S500	DAP15S800
B 25 cts	D	P	DB 25P064	DB 25P364	DB 25P431	DB 25P631	DB 25P564	DB 25P864
		S	DB 25S064	DB 25S364	DB 25S431	DB 25S631	DB 25S564	DB 25S864
	DP	P	DBP25P	DBP25P300	DBP25P400	DBP25P600	DBP25P500	DBP25P800
		S	DBP25S	DBP25S300	DBP25S400	DBP25S600	DBP25S500	DBP25S800
C 37 cts	D	P	DC 37P064	DC 37P364	DC 37P431	DC 37P631	DC 37P564	DC 37P864
		S	DC 37S064	DC 37S364	DC 37S431	DC 37S631	DC 37S564	DC 37S864
	DP	P	DCP37P	DCP37P300	DCP37P400	DCP37P600	DCP37P500	DCP37P800
		S	DCP37S	DCP37S300	DCP37S400	DCP37S600	DCP37S500	DCP37S800
D 50 cts	D	P	DD 50P064	DD 50P364	DD 50P431	DD 50P631	DD 50P564	DD 50P864
		S	DD 50S064	DD 50S364	DD 50S431	DD 50S631	DD 50S564	DD 50S864
	DP	P	DDP50P	DDP50P300	DDP50P400	DDP50P600	DDP50P500	DDP50P800
		S	DDP50S	DDP50S300	DDP50S400	DDP50S600	DDP50S500	DDP50S800

part number appendices (to be inserted after initial letters of part number)

- F : Float mounting — insert letter F for float mounting connectors. eg. DBF25P064
- L : Riveted nuts (M3) — insert letter L for connectors with M3 riveted nuts. eg. DBL25P064
- O : Riveted nuts (UNC4-40) — insert letter O for connectors with UNC 4-40 riveted nuts. eg. DBO25P064
- V : Screw locking — insert letter V for connectors with mounted female locking posts. eg. DBV25P064

part number suffixes

- C : Plastic brackets — add suffix C to part number of angled spill connectors when plastic mounting brackets are NOT required. eg. DB25P564C
- M : Metal brackets — add suffix M to part number of angled spill connectors when metal mounting brackets are required in place of standard plastic brackets. eg. DB25P564M
- T : Tin plating — D and DP connectors can be supplied with tin plated shells — add suffix T to end of part number if required. eg. DB25P064T (male and female shells)
- X : Electrical continuity — for versions with enhanced electrical continuity add suffix X to end of part number. eg. DB25P064X (tin plated male shells only)

Note: where more than one suffix is applicable, add in alphabetical order

This range has been approved on
Pattern 110/BS9523 gauges

industrial crimp D-sub connectors (8634 series)

layouts male insulator front view

contacts are individually numbered on both sides of the insulator

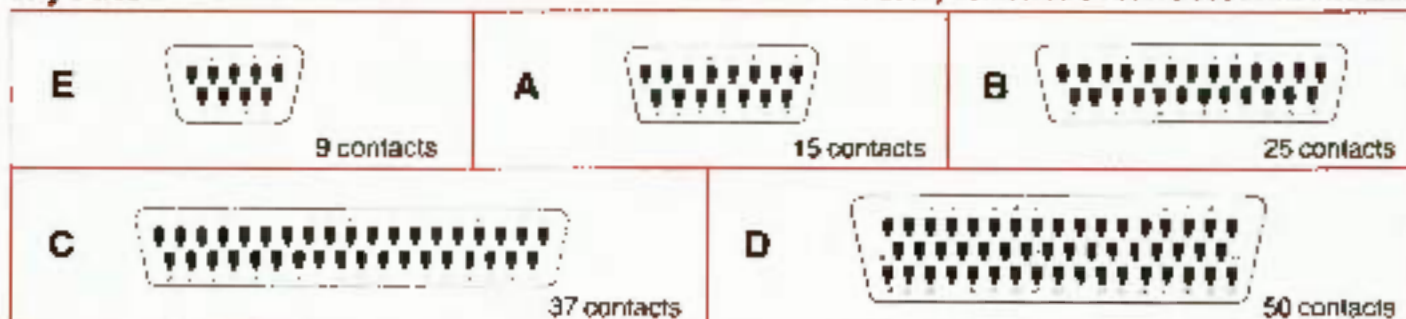

ordering information

(connectors without contacts)

shell size	series	male or female	standard rigid mount	float mount
E 9 cts	8634	P	8634 09PL	8634F 09PL
		S	8634 09SL	8634F 09SL
A 15 cts	8634	P	8634 15PL	8634F 15PL
		S	8634 15SL	8634F 15SL
B 25 cts	8634	P	8634 25PL	8634F 25PL
		S	8634 25SL	8634F 25SL
C 37 cts	8634	P	8634 37PL	8634F 37PL
		S	8634 37SL	8634F 37SL
D 50 cts	8634	P	8634 50PL	8634F 50PL
		S	8634 50SL	8634F 50SL

part number appendices (to be inserted after initial letters of part number (for fuller explanation of appendices see D/DP series page 7))

L : Riveted nuts (M3) e.g. 8634L 25PL
Q : Riveted nuts (UNC4-40) e.g. 8634 Q25PL
V : Screw locking e.g. 8634 V25PL

part number suffixes (to be added to end of part number)

T : Tin plating - 8634 connectors with tin plated shells add suffix T to end of part number e.g. 8634 25PLT
X : Electrical continuity for versions with enhanced electrical continuity add suffix X to end of part number (male only) e.g. 8634 25PLX

tooling part numbers

Manual crimp tool for: AWG 20/24 8634-271
AWG 26/28: 8634-272A

Manual crimp tool for 500 contact reel

AWG 20/24: 5106-016-05-01

Plastic extraction tool (supplied with connector): 8634-210

automatic crimping

Pneumatic equipment.

● 1000 crimps per hour

● Automatic strip and crimp initiated by wire insertion

● Double crimp of core and sleeve

Automatic crimp machine complete with tooling for:

- AWG 20/24: 8506-8634B

- AWG 26/28: 8506-86345A

contact part numbers

part numbers (contacts to be ordered separately)

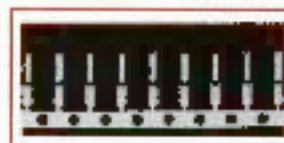

AWG 20/24

packaging	plating	male	female
reel of 10,000	1	8634-220	8634-221
	2	8634-220-064	8634-221-064
box of 500 individual contacts	1	8634-234	8634-235
	2	8634-234-064	8634-235-064
reel of 500	1	8634-220-500	8634-221-500
	2	8634-220-064-500	8634-221-064-500

AWG 26/28

packaging	plating	male	female
reel of 5,000	1	8634-4510	8634-8610
	2	8634-4510-064	8634-8610-064
reel of 1,000	1	8634-4110	8634-8110
	2	8634-4110-064	8634-8110-064
box of 500 individual contacts	1	8634-350	8634-351
	2	8634-350-064	8634-351-064



insulation displacement D-sub connectors

(8657 & 8658 series)

layouts male insulator front view

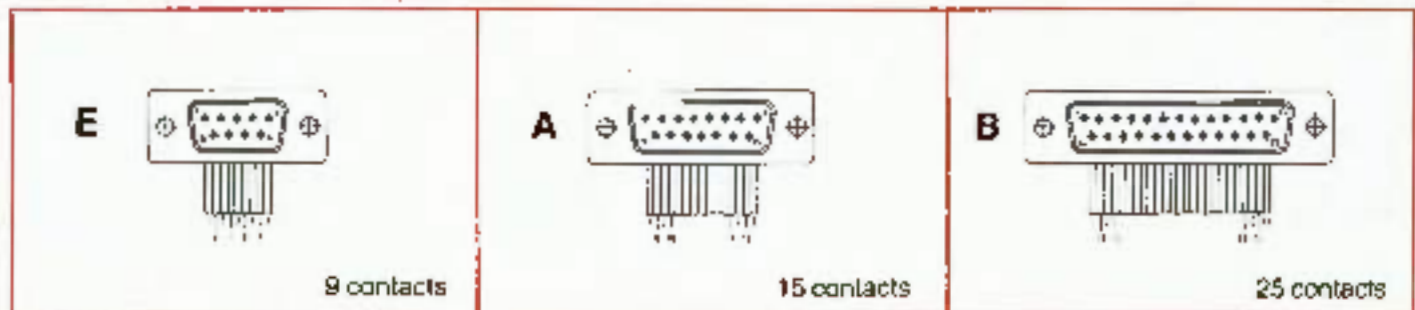

ordering information

shell size	series	flat cable		discrete wire	
		zinc plated shell	tin plated shell	zinc plated shell	tin plated shell
E 9 cts	P	8657 09P064	8657 09P064T	8658 09P064	8658 09P064T
	S	8657 09S064	8657 09S064T	8658 09S064	8658 09S064T
A 15 cts	P	8657 15P064	8657 15P064T	8658 15P064	8658 15P064T
	S	8657 15S064	8657 15S064T	8658 15S064	8658 15S064T
B 25 cts	P	8657 25P064	8657 25P064T	8658 25P064	8658 25P064T
	S	8657 25S064	8657 25S064T	8658 25S064	8658 25S064T

flat cable dimensions & harnesses

Connector terminations are on a uniform 1.27mm (0.05") pitch.
Cables are centrally located within the insulator.

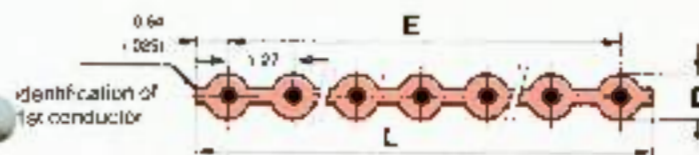

no. of conductors	insulation thickness D ± 0.13 (.005)	L = total width	E ± 0.2 (.007)
9	0.89 (.035)	11.43 (0.45)	10.16 (0.4)
15	0.89 (.035)	19.05 (0.75)	17.78 (0.7)
25	0.89 (.035)	31.75 (1.25)	30.48 (1.2)

series	8657	1	25	2	49	8
1 - multistrand conductor						
2 - single core conductor						
No. of contacts 09, 15, 25						
Harness configuration 1, 2, 3, 4, 5, 6, see table to right						
Connector combinations						
48 - male/male						
52 female/female						
49 - male/female						
53 female/male						
Cable length						
0 = 60mm						
3 = 130mm						
6 = 260mm						
9 = 500mm						
1 = 80mm						
4 = 160mm						
7 = 320mm						
2 = 100mm						
5 = 200mm						
8 = 400mm						

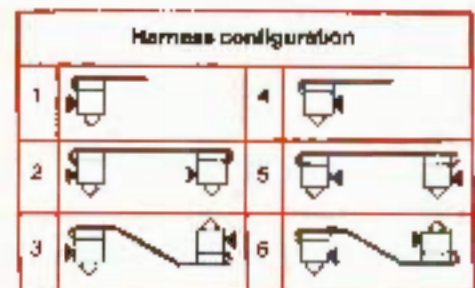

► polarising mark

termination tooling

Hand pliers with table feature
(for flat cable termination)
Cutting insert with support plate
Pressing guide bracket with slide
Cabling table
Table support

8657-A71-A20
8657-A71-A29
8657-A71-A25
8657-A71-A29
8657-A71-A31

Press-in insert and guide for flat cable
(male connectors)

8657-A59-D39

Press-in insert and guide for flat cable
(female connectors)

8657-A59-D40

Toggle lever press with guide support and slide
(for flat cable and discrete wire termination)

8657-A71-A23

Electrical drive unit

8657-A71-A24

Cutting insert with support plate

8657-A71-A28

Pressing guide bracket (included in with press)

8657-A71-A29

includes
MIL-C-24308A
 series
 QPL approved

high spec.
 D-sub
 connectors
 (DM series) Mk. 1

This range has been approved on
 Pattern 110/BS9523 gauges

layouts male Insulator front view

contacts are individually numbered on both sides of the insulator

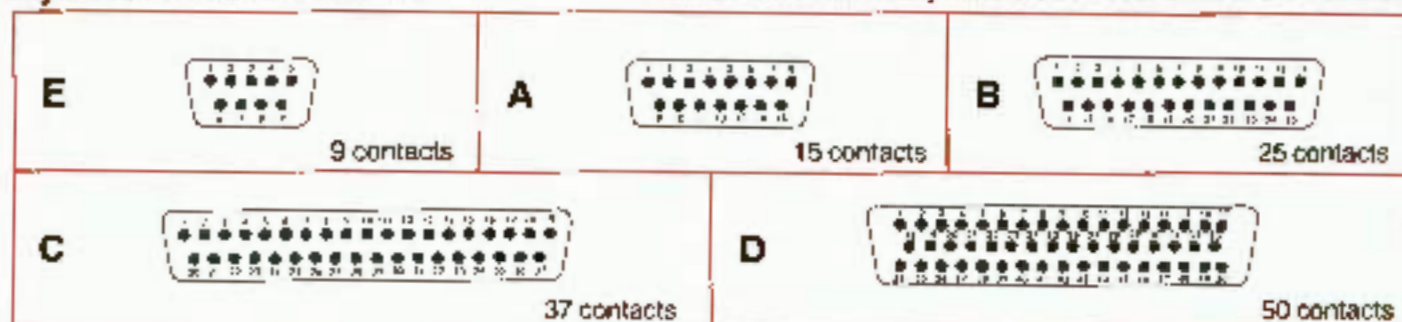

ordering information

shell size	series	male or female	solder bucket	straight spill	wire wrap		angled spill with riveted plastic mounting brackets (c)	
					(3 wraps)	(2 wraps)	2.54mm pitch between rows	2.84 pitch between rows
E 9 cts	DM	P	DEM 09P	DEM 09P300	DEM 09P400	DEM 09P600	DEM 09P500	DEM 09P800
		S	DEM 09S	DEM 09S300	DEM 09S400	DEM 09S600	DEM 09S500	DEM 09S800
A 15 cts	DM	P	DAM 15P	DAM 15P300	DAM 15P400	DAM 15P600	DAM 15P500	DAM 15P800
		S	DAM 15S	DAM 15S300	DAM 15S400	DAM 15S600	DAM 15S500	DAM 15S800
B 25 cts	DM	P	DBM 25P	DBM 25P300	DBM 25P400	DBM 25P600	DBM 25P500	DBM 25P800
		S	DBM 25S	DBM 25S300	DBM 25S400	DBM 25S600	DBM 25S500	DBM 25S800
C 37 cts	DM	P	DCM 37P	DCM 37P300	DCM 37P400	DCM 37P600	DCM 37P500	DCM 37P800
		S	DCM 37S	DCM 37S300	DCM 37S400	DCM 37S600	DCM 37S500	DCM 37S800
D 50 cts	DM	P	DDM 50P	DDM 50P300	DDM 50P400	DDM 50P600	DDM 50P500	DDM 50P800
		S	DDM 50S	DDM 50S300	DDM 50S400	DDM 50S600	DDM 50S500	DDM 50S800

part number appendices (to be inserted after initial letters of part number):

- F : Float mounting - insert letter F for float mounting connectors, e.g. DEM F09P
- L : Riveted nuts (M3) - insert letter L for connectors with M3 riveted nuts, e.g. DM L09P
- O : Riveted nuts (UNC4-40) - insert letter O for connectors with UNC4-40 riveted nuts, e.g. DEM O09P
- V : Screw locking - insert letter V for connectors with mounted female locking posts, e.g. DEM V09P

part number suffixes

- C : Plastic brackets - add suffix C to part number of angled spill connectors when plastic mounting brackets are NOT required, e.g. DEM 09P500C
- M : Metal brackets - add suffix M to part number of angled spill connectors when metal mounting brackets are required in place of standard plastic brackets, e.g. DEM 09P500M
- T : Tin plating - DM connectors can be supplied with tin plated shells - add suffix T to end of part number if required, e.g. DEM 09PT
- X : Electrical continuity - for versions with enhanced electrical continuity add suffix X to end of part number (male connectors only)
- 032 : MIL spec. - for versions to MIL-C-24308A add suffix -032 to end of part number, e.g. DEM 09P-032

Note: where more than one suffix is applicable, add in alphabetical order.

MIL-C-24308A

Souriau DM series (Mk. 1), solder bucket connectors can be ordered against equivalent MIL-C-24308A part numbers. For cross reference details see page 39 of this catalogue.

power and coaxial D-sub connectors

(DMW series)

power contacts (size 8)

Wire size	Max. Current	Part numbers		Wire size	Max. Current	Part numbers	
		Male	Female			Male	Female
AWG8	40A	8630-3066A	8630-3069A	AWG14	15A	8630-3060A	8630-3061A
AWG12	20A	8630-3056A	8630-3057A	AWG16	10A	8630-3064A	8630-3065A

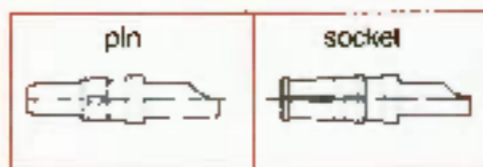

coaxial contacts, cable & connector dimensions

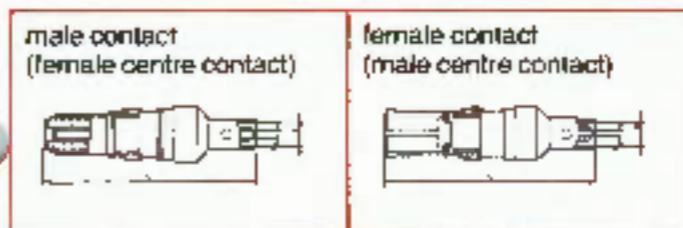

straight



cable

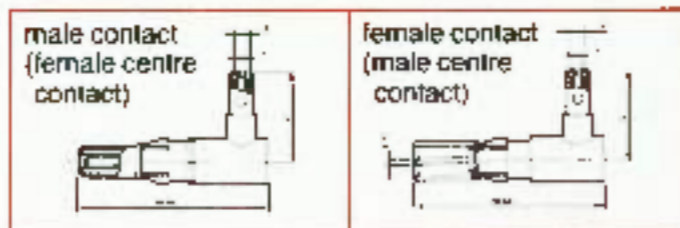

angled

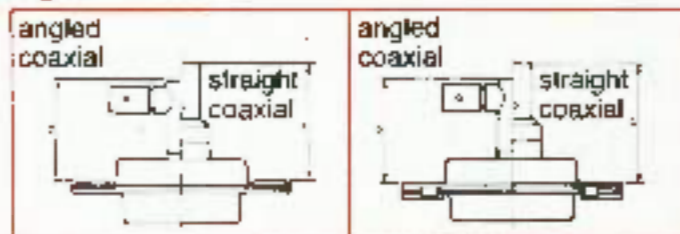

rigid mount

float mount

contact types		part numbers		contact dimensions						recommended cable types				
		screen solder	screen crimp	A ±0.1 +0	B ±0.1 +0	C	D	E	F	G	MLC 17E	NFC 83-89	CEI No. 95	Impedance at 200MHz
straight	male	DM53740-5008A	DM53740-A	1.0	2.32	23.60		0.30	0.90	2.20	RG178BU		50.1 A.1	50Ω ± 2%
		DM53740-5000A				21.80					RG178BU			
angled	female	DM53742-5006A	DM53742-A	1.0	2.32	23.60		0.30	0.90	2.20	RG178BU		50.1 A	50Ω ± 2%
		DM53742-5000A				21.80						KX21A		50Ω ± 5%
angled	male	DM53741-5000A	DM53741-A	1.0	2.32		21.80	0.30	0.90	2.20	RG178BU			
	female	DM53742-5000A	DM53742-A	1.0	2.32		21.80	0.30	0.90	2.20	RG178BU			
straight	male	DM53740-5001A	DM53740-1A	1.7	3.13	23.60		0.51	1.60	3.0		KX3A	5.2.1	50Ω ± 3.5%
	female	DM53742-5001A	DM53742-1A	1.7	3.13	23.60		0.51	1.60	3.0	RG179BU		75.2 A 75.2 A.1	75Ω ± 3%
angled	male	DM53741-5001A	DM53741-1A	1.7	3.13		23.60	0.51	1.60	3.0	RG179BU		50.2 A.1 50.2.2	50Ω ± 2%
	female	DM53743-5001A	DM53743-A	1.7	3.13		23.60	0.51	1.60	3.0		KX22A		50Ω ± 2%
straight	male	DM53740-5002A	DM53740-2A	2.65	5.09	26.30		0.30	2.60	5.0	RG180BU			95Ω ± 5%
	female	DM53742-5002A	DM53742-2A	2.65	5.09	26.30		0.30	2.60	5.0	RG180BU			95Ω ± 5%
angled	male	DM53741-5002A	DM53741-2A	2.65	5.09		26.30	0.30	2.60	5.0	RG180BU			95Ω ± 3%
	female	DM53743-5003A	DM53743-A	2.65	5.09		26.30	0.30	2.60	5.0	RG180BU			95Ω ± 3%
straight	male	DM53740-5005A	DM53740-5A	3.15	5.09	26.30		0.90	3.0	5.0	RG58CU	KX15	50.3.1	50Ω ± 2%
	female	DM53742-5004A	DM53742-5A	3.15	5.09	26.30		0.90	3.0	5.0	RG58CU		50.3 A.2	50Ω ± 2%
angled	male	DM53741-5004A	DM53741-4A	3.15	5.09		26.30	0.90	3.0	5.0	RG58CU			50Ω ± 2%
	female	DM53743-5004A	DM53743-4A	3.15	5.09		26.30	0.90	3.0	5.0	RG58CU			50Ω ± 2%

MIL-C-24308A

series
QPL approved

high spec.
removable crimp
D-sub
connectors
(8630 series) Mk. 3

layouts male insulator front view

contacts are individually numbered on both sides of the insulator

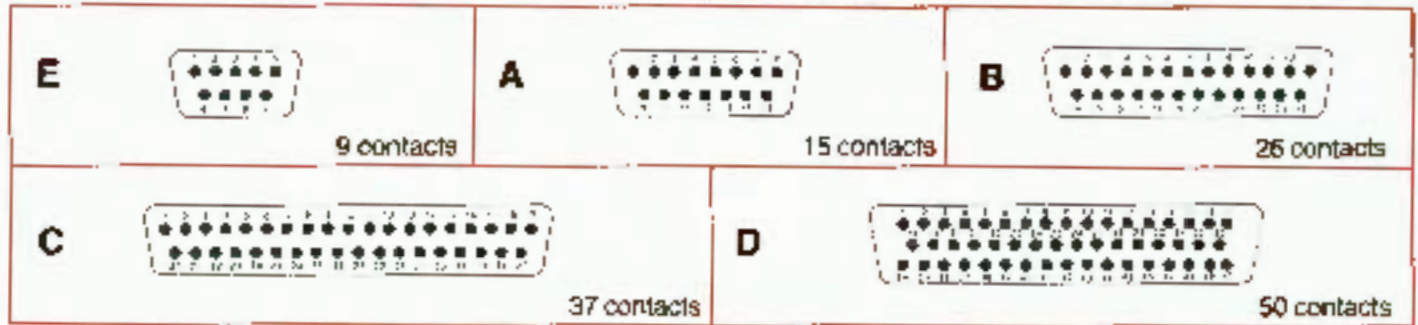

Ordering information

shell size	series	mounting style	rigid mounting			flot mounting		
			standard connectors	connectors with grommet	sealed connectors*	standard connectors	connectors with grommet	sealed connectors†
E 9 cts	8630	P	8630 09P	8630 09P015	8630 09P012*	8631 09P	8631 09P015	8631 09P012*
		S	8630 09S	8630 09S015	8630 09S012*	8631 09S	8631 09S015	8631 09S012*
A 15 cts	8630	P	8630 15P	8630 15P015	8630 15P012*	8631 15P	8631 15P015	8631 15P012*
		S	8630 15S	8630 15S015	8630 15S012*	8631 15S	8631 15S015	8631 15S012*
B 25 cts	8630	P	8630 25P	8630 25P015	8630 25P012*	8631 25P	8631 25P015	8631 25P012*
		S	8630 25S	8630 25S015	8630 25S012*	8631 25S	8631 25S015	8631 25S012*
C 37 cts	8630	P	8630 37P	8630 37P015	8630 37P012*	8631 37P	8631 37P015	8631 37P012*
		S	8630 37S	8630 37S015	8630 37S012*	8631 37S	8631 37S015	8631 37S012*
D 50 cts	8630	P	8630 50P	8630 50P015	8630 50P012	8631 50P	8631 50P015	8631 50P012
		S	8630 50S	8630 50S015	8630 50S012	8631 50S	8631 50S015	8631 50S012

suffix L: No contacts - add suffix L to part number of crimp connectors when standard contacts are NOT required

*: Please consult us for availability of these types

†: The suffix -012 sealed grommet also provides an interfacial seal on air contact connectors

alternative contacts and part numbers (should be ordered separately)

AWG		standard copper alloys	constantan	thermo-couple		alumel
				cuprotel kermum	chromel	
20/24	pin	8630-182	8630-488	8630-487	8630-432	8630-433
	socket	8630-185	8630-488	8630-469	8630-434	8630-435
25/28	pin	8630-4831				
	socket	8630-6871	Reducing sleeve for 1 mm dia contacts, wire size 0.08 to 0.21mm ² : 8630-292			

MIL-C-24308A contacts

		Souriau pt. no.	MIL-C-24308A pt. no.
AWG 20/24	pin	8630-3020A	MIL-C-39029-84A
	socket	8630-4020A	MIL-C-39029-83A

Souriau 8630 crimp connectors can be ordered against equivalent MIL-C-24308A (S*MA series) part numbers. For cross reference details see page 35 of this catalogue.

high density D-sub connectors (8635 series)

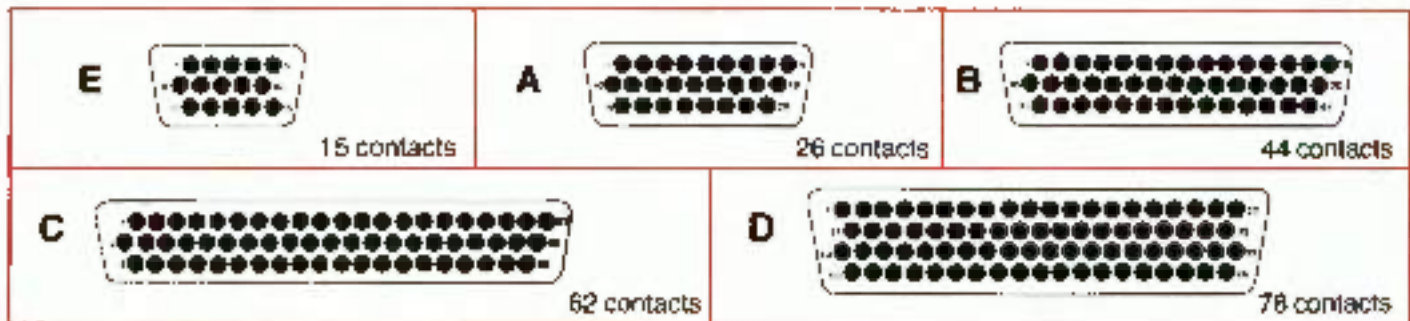

ordering information

shell size	series	pin or socket	rigid mounting			float mounting		
			standard connectors	connectors with grommet	sealed connectors	standard connectors	connectors with grommet	sealed connectors
E 15 cts	8635	P	8635 15P	8635 15P015	8635 15P012*	8635F15P	8635F15P015	8635F15P012*
		S	8635 15S	8635 15S015	8635 15S012*	8635F15S	8635F15S015	8635F15S012*
A* 26 cts	8635	P	8635 26P	8635 26P015	8635 26P012*	8635F26P	8635F26P015	8635F26P012*
		S	8635 26S	8635 26S015	8635 26S012*	8635F26S	8635F26S015	8635F26S012*
B 44 cts	8635	P	8635 44P	8635 44P015	8635 44P012*	8635F44P	8635F44P015	8635F44P012*
		S	8635 44S	8635 44S015	8635 44S012*	8635F44S	8635F44S015	8635F44S012*
C* 62 cts	8635	P	8635 62P	8635 62P015	8635 62P012*	8635F62P	8635F62P015	8635F62P012*
		S	8635 62S	8635 62S015	8635 62S012*	8635F62S	8635F62S015	8635F62S012*
D 78 cts	8635	P	8635 78P	8635 78P015	8635 78P012	8635F78P	8635F78P015	8635F78P012
		S	8635 78S	8635 78S015	8635 78S012	8635F78S	8635F78S015	8635F78S012

Please consult us for availability of all 26 and 62 contacts types and also sealed versions of 15 and 44 contact layouts

suffix L : No contacts – add suffix L to part number of crimp connectors when standard contacts are NOT required

† : The suffix -012 sealed grommet also provides an interfacial seal on pin contact connectors

contact part numbers

		type	part number
standard		pin	8599-0722
		socket	8599-0723
MIL-C-24308A	pin	Souriau	8599-0902
		MIL	MS 39029/58-360
	socket	Souriau	8599-0910
		MIL	MS 39029/57-354

MIL-C-24308A

Souriau 8635 crimp connectors can be ordered against equivalent MIL-C-24308A (S*MA series) part numbers. For cross reference details see page 35 of this catalogue.

MIL-C-24308

class N

QPL approved

non-magnetic
D-sub
connectors
(DM/8630 NM series)

layouts male insulator front view

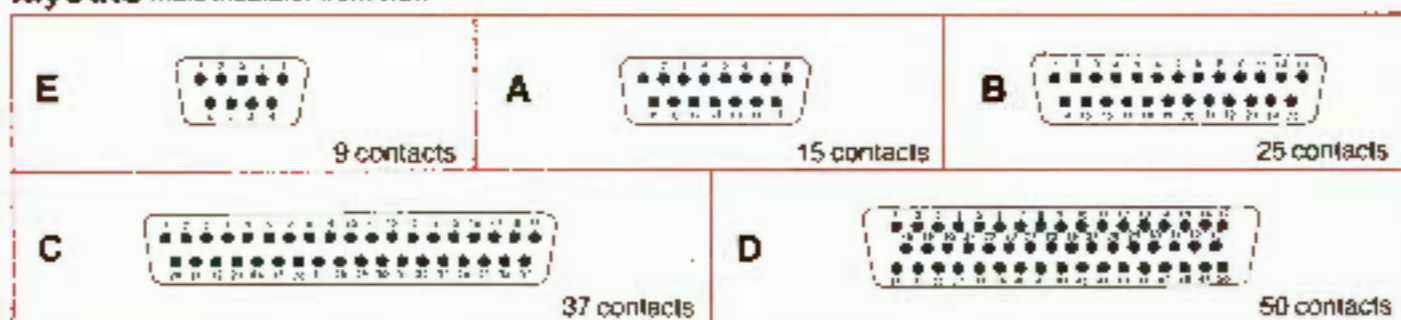

ordering information

- standard non-magnetic DM and 8630 connector shells are cadmium plated
- For 1.27 micron gold plated versions DELETE suffix A from part numbers shown

solder bucket, straight spill and angled spill versions

shell size	series	male or female	solder bucket	straight spill	angled spill
E 9 cts	DM non-magnetic	P	DEM09P 011NMA	DEM09P 232NMA	DEM09P 732NMA
		S	DEM09S 011NMA	DEM09S 232NMA	DEM09S 732NMA
A 15 cts	DM non-magnetic	P	DAM15P 011NMA	DAM15P 232NMA	DAM15P 732NMA
		S	DAM15S 011NMA	DAM15S 232NMA	DAM15S 732NMA
B 25 cts	DM non-magnetic	P	DBM25P 011NMA	DBM25P 232NMA	DBM25P 732NMA
		S	DBM25S 011NMA	DBM25S 232NMA	DBM25S 732NMA
C 37 cts	DM non-magnetic	P	DCM37P 011NMA	DCM37P 232NMA	DCM37P 732NMA
		S	DCM37S 011NMA	DCM37S 232NMA	DCM37S 732NMA
D 50 cts	DM non-magnetic	P	DDM50P 011NMA	DDM50P 232NMA	DDM50P 732NMA
		S	DDM50S 011NMA	DDM50S 232NMA	DDM50S 732NMA

Float mounting: insert F after the letter M if float mounting connectors are required.

crimp versions

shell size	series	male or female	rigid mounting		float mounting	
			with contacts	without contacts	with contacts	without contacts
E 9 cts	8630 non-magnetic	P	863009P 011NMA	863009P 011NMAL	863109P 011NMA	863109P 011NMAL
		S	863009S 011NMA	863009S 011NMAL	863109S 011NMA	863109S 011NMAL
A 15 cts	8630 non-magnetic	P	863015P 011NMA	863015P 011NMAL	863115P 011NMA	863115P 011NMAL
		S	863015S 011NMA	863015S 011NMAL	863115S 011NMA	863115S 011NMAL
B 25 cts	8630 non-magnetic	P	863025P 011NMA	863025P 011NMAL	863125P 011NMA	863125P 011NMAL
		S	863025S 011NMA	863025S 011NMAL	863125S 011NMA	863125S 011NMAL
C 37 cts	8630 non-magnetic	P	863037P 011NMA	863037P 011NMAL	863137P 011NMA	863137P 011NMAL
		S	863037S 011NMA	863037S 011NMAL	863137S 011NMA	863137S 011NMAL
D 50 cts	8630 non-magnetic	P	863050P 011NMA	863050P 011NMAL	863150P 011NMA	863150P 011NMAL
		S	863050S 011NMA	863050S 011NMAL	863150S 011NMA	863150S 011NMAL

filter D-sub connectors

(DJ series)

layouts male insulator front view

contacts are individually numbered on both sides of the insulator

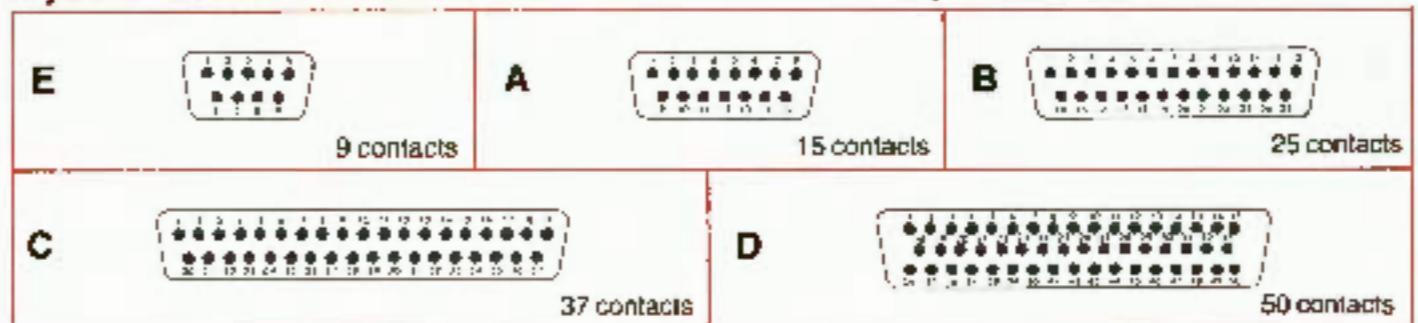

ordering information

– mid-range frequency Pi filter connectors

For other filters and specials, see notes below this table.

shell size	series	male or female	solder bucket	straight spill	angled spill	
					2.54mm pitch between rows	2.84mm pitch between rows
E 9 cts	DJ filter	P	DEJ 09PM	DEJ 09P300M	DEJ 09P500M	DEJ 09P800M
		S	DEJ 09SM	DEJ 09S300M	DEJ 09S500M	DEJ 09S800M
A 15 cts	DJ filter	P	DAJ 15PM	DAJ 15P300M	DAJ 15P500M	DAJ 15P800M
		S	DAJ 15SM	DAJ 15S300M	DAJ 15S500M	DAJ 15S800M
B 25 cts	DJ filter	P	DBJ 25PM	DBJ 25P300M	DBJ 25P500M	DBJ 25P800M
		S	DBJ 25SM	DBJ 25S300M	DBJ 25S500M	DBJ 25S800M
C 37 cts	DJ filter	P	DCJ 37PM	DCJ 37P300M	DCJ 37P500M	DCJ 37P800M
		S	DCJ 37SM	DCJ 37S300M	DCJ 37S500M	DCJ 37S800M
D 50 cts	DJ filter	P	DDJ 50PM	DDJ 50P300M	DDJ 50P500M	DDJ 50P800M
		S	DDJ 50SM	DDJ 50S300M	DDJ 50S500M	DDJ 50S800M

Note 1. To order D-sub connectors with alternative filter contacts as described opposite, replace the filter series letter M in the part number by the letter corresponding to the filter series required.

- i.e.
- T – standard frequency Pi filter
 - H – high frequency Pi filter
 - B – low frequency C filter
 - MC – mid range frequency C filter
 - TC – standard frequency C filter
 - HC – high frequency C filter

e.g. DEJ 09P300TC – a 9 contact male connector with straight spill terminations fitted with standard frequency C filters.
DCJ 37SH – a 37 contact female connector with solder bucket terminations fitted with high frequency Pi filters.

Note 2. A 3 digit modification part number suffix to cover special versions of filter D-sub connectors can be supplied by Souriau to cover versions such as:-
– partially filtered connectors having contact combinations with an earth non-filtered contact or EMI sealing plug.
– connectors having more than one type of filter contact. (In this case no filter series letter appears in the part number.)
– connectors with specific shell plating

Note 3. For wire wrap versions – consult us

outline dimensions for full shell outline dimensions see page 32

Contact dimensions, excluding angled spill version, are as shown on page 6 (for angled spill version the dimension marked X becomes 17.5mm ± 0.1)

hermetic D-sub connectors (DH series)

layouts

contacts are individually numbered on both sides of the insulator

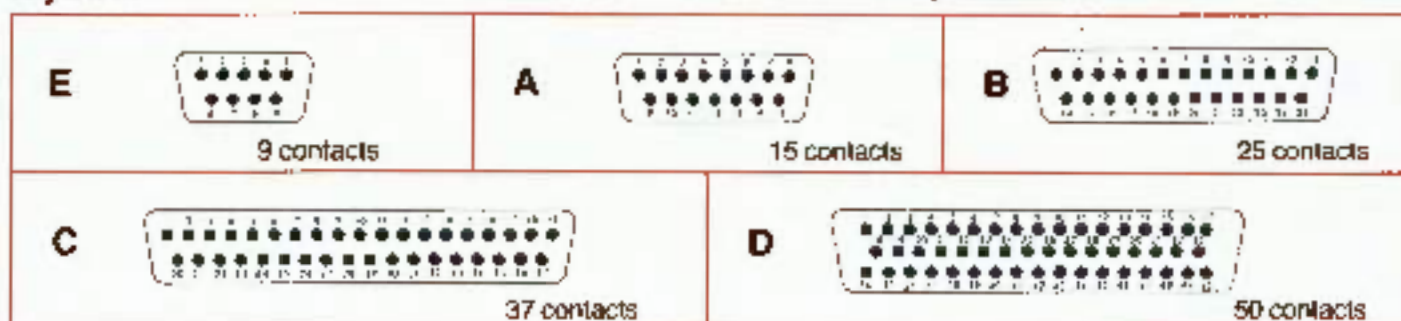

ordering information including alternative fixings

shell size	series	plating	panel solder fixing				panel screw fixing	
			without locking studs		with locking studs		solder bucket contacts	straight spill contacts
			solder bucket contacts	straight spill contacts	solder bucket contacts	straight spill contacts		
E 9 cts	DH	cadmium gold	DEH09P002	DEH09P004	DEH09P006	DEH09P008	DEH09P102	DEH09P104
		tinneled gold	DEH09P007			DEH09P010	DEH09P107	
		tinneled tinneled			DEH09P005	DEH09P009		
A 15 cts	DH	cadmium gold	DAH15P002	DAH15P004	DAH15P006	DAH15P008	DAH15P102	DAH15P104
		tinneled gold	DAH15P007			DAH15P010	DAH15P107	
		tinneled tinneled			DAH15P005	DAH15P009		
B 25 cts	DH	cadmium gold	DBH25P002	DBH25P004	DBH25P006	DBH25P008	DBH25P102	DBH25P104
		tinneled gold	DBH25P007			DBH25P010	DBH25P107	
		tinneled tinneled			DBH25P005	DBH25P009		
C 37 cts	DH	cadmium gold	DCH37P002	DCH37P004	DCH37P006	DCH37P008	DCH37P102	DCH37P104
		tinneled gold	DCH37P007			DCH37P010	DCH37P107	
		tinneled tinneled			DCH37P005	DCH37P009		
D 50 cts	DH	cadmium gold	DDH50P002	DDH50P004	DDH50P006	DDH50P008	DDH50P102	DDH50P104
		tinneled gold	DDH50P007			DDH50P010	DDH50P107	
		tinneled tinneled			DDH50P005	DDH50P009		

outline dimensions see opposite

shell size	A	B	C screw fixing	D	E	G max.	H	J	K
E	30.80	16.94	24.80	8.41	12.54	8.50	18.40	9.40	2.90
A	39.14	25.27	33.32	8.41	12.54	8.50	23.70	9.40	2.50
B	63.03	39.00	47.04	8.41	12.54	8.48	37.58	9.40	2.90
C	69.29	55.45	63.50	8.41	12.54	8.40	53.97	9.40	2.70
D	68.62	52.86	61.11	11.10	15.36	8.40	50.60	12.70	2.70

D-sub connector hoods

SOURDAN UK

Straight and right angle hoods

Material: thermoplastic
 Temperature range: -55°C to +125°C
 Colour: Grey

shell size	part number	
	straight	right angle
E	8630-5165-09	8630-5165-09R
A	8630-5165-15	8630-5165-15R
B	8630-5165-25	8630-5165-25R
C	8630-5165-37	8630-5165-37R
D	8630-5165-50	8630-5165-50R

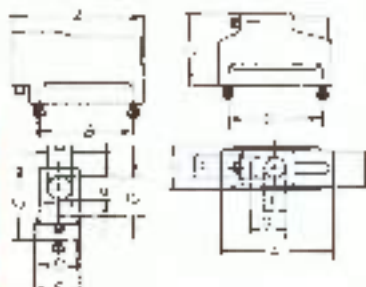

Right angle hood

As the right angle hood above but
 Material: Self extinguishing UL rated 94V-0 thermoplastic
 Temperature range: 55°C to +125°C
 Colour: Black
 25 way hood Part number 8630-3672

shell size	At	Aa	B	C	D	E	F	G	H
E	30.9	38.0	25.0	25.4	12.7	14.3	7.1	—	7.1
A	39.3	46.3	33.3	25.4	12.7	14.3	9.1	—	9.1
B	53.2	60.1	47.0	31.7	12.7	14.3	—	12.5	9.1
C	69.4	76.4	63.5	38.1	12.7	14.3	—	17.6	9.1
D	67.1	74.0	61.1	38.1	15.5	17.0	—	18.6	11.9

Plastic straight exit hoods

Material: Self extinguishing UL rated 94V-0 thermoplastic
 Temperature range: 55°C to +125°C
 Colour: Black

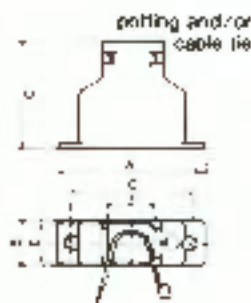

shell size	part number
E	8630-86A
A	8630-21A
B	8630-22A
C	8630-23A
D	8630-24A

shell size	A	B	C	D	E	F
E	30.80	12.50	25.00	29.00	9.90	9.90
A	38.90	12.50	33.32	29.00	9.90	11.90
B	52.80	12.50	47.05	35.00	9.90	16.40
C	69.10	12.50	63.50	41.00	9.90	23.40
D	66.70	15.30	61.10	41.00	12.70	23.40

Material: Self extinguishing UL rated 94V-0 thermoplastic
 Temperature range: -55°C to +125°C
 Colour: Black

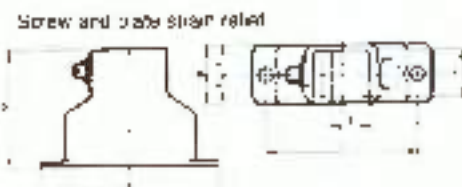

shell size	part number
E	8630-3920
A	8630-3921
B	8630-3922
C	8630-3923
D	8630-3924

shell size	A	B	C	D	Estr	Estr	F
E	30.80	12.50	25.00	29.00	2.70	2.70	10.50
A	38.90	12.50	33.32	29.00	4.50	9.10	10.50
B	52.80	12.50	47.05	35.00	9.20	13.60	10.50
C	69.10	12.50	63.50	41.00	9.20	20.80	10.50
D	66.70	15.30	61.10	41.00	9.20	20.60	13.30

D-sub connector accessories & reference data

RS232/IEEE 488 interfaces and Gender changers

RS232 Adaptor

A compact adaptor used to facilitate cross-linking on 25 way RS232 Data Interfaces or as a gender changer. Also suitable for use as a test equipment connector saver. Removable 2 part plastic cover with interlocking screws for custom modification.

- 3 versions: male to male - part no: 8630-GCMM25
- male to female - part no: 8630-GCMF25
- female to female - part no: 8630-GCFH25

IEC 625 to IEEE 488 Adaptor

Compact adaptor to facilitate direct interconnection between equipments with IEC 625 output to IEEE 488 output, these being the standard bus systems used in Europe and the U.S.A. Complete with interlocking screws.

- part no. 8630-S202F

IEEE 488 to IEC 625 Adaptor

As above but in reverse format.

- part no. 8630-S102F

IEEE 488 (GPIB) Cable Assembly

Used extensively throughout the computer and peripheral market, they enable up to 15 bus compatible units to be connected together. Standard 1 and 2 metre lengths. Other lengths and shielded versions available on request.

- 1 metre length - part no. 8630-IEEE/1
- 2 metres length - part no. 8630-IEEE/2

IEEE 488 (GPIB) Reverse Adaptor Block

Converts the GPIB cable assembly above from 'left-handed' format to 'right-handed' format. Fully shielded against RFI and EMI.

- part no. 8630-S302F



IEC 625/IEEE 488 adaptor (left) and RS 232 adaptor (right)



IEEE 488 cable assemblies and reverse adaptor block

panel mounting:

It is recommended that only one of a pair of connectors should have a float mounting. Right mounting connectors require 2 screws @ 3mm, float mounting connectors require 2 screws @ 2mm.

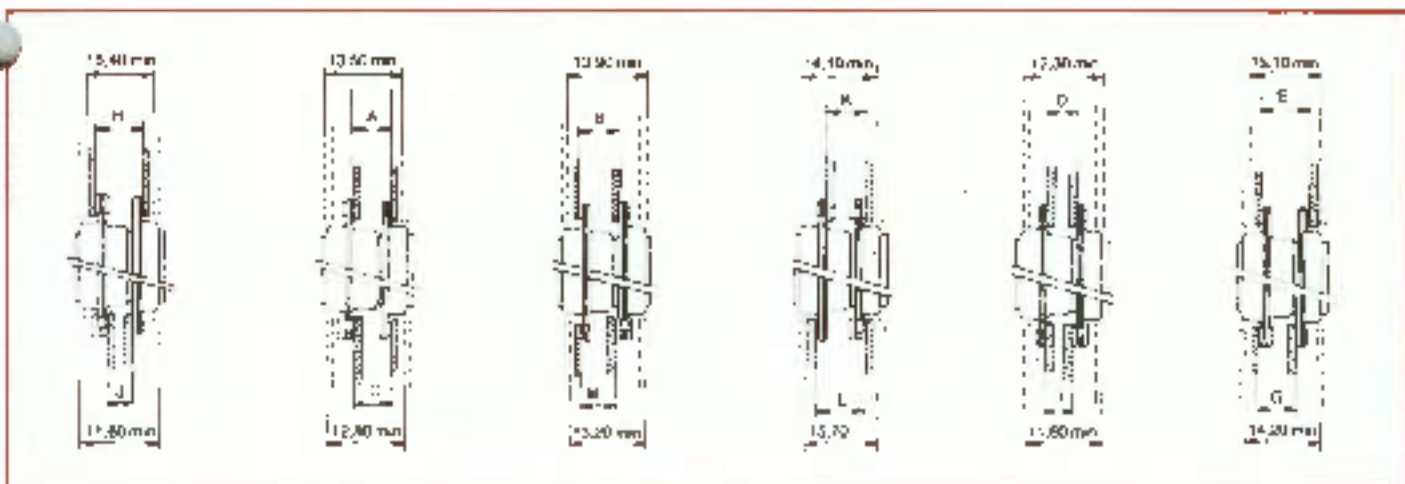

shell size	A	B	C	D	E	F	G	H	J	K	L	M
E	7.65	7.65	6.85	6.45	8.85	5.65	8.25	9.45	5.65	8.25	9.45	6.85
A	7.65	7.85	6.85	6.45	8.85	5.65	8.25	9.45	5.65	8.25	9.45	8.85
B	7.55	7.55	6.75	6.35	8.75	5.55	8.15	9.35	5.55	8.15	9.35	8.75
C	7.55	7.95	6.75	6.35	9.15	5.55	8.35	9.55	5.55	8.15	9.75	7.15
D	7.55	7.95	6.75	6.85	9.15	5.55	8.35	9.55	5.55	8.15	9.75	7.15

D-sub connector reference data

panel cutouts:

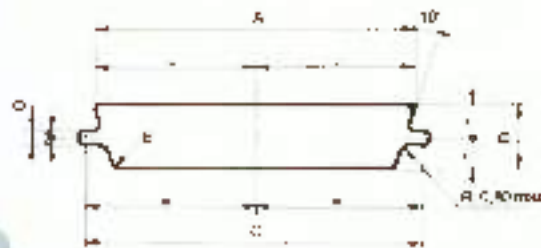

cutout for mounting from rear of panel only

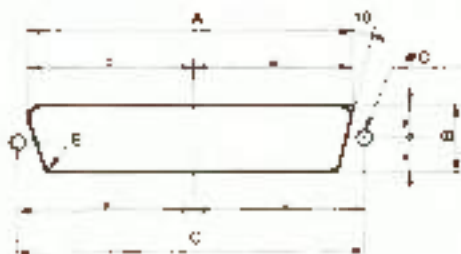

shell size	type of mounting	mounting position	A ±0.1	B ±0.1	C ±0.1	D ±0.05	E ±0.1
E	rigid	front	22.20	13.00	24.99	3.20	2.10
		rear	20.50	11.40	24.99	3.20	3.30
	float	front	23.00	13.80	24.99	2.20	2.10
		rear	21.30	12.20	24.99	2.20	3.30
A	rigid	front	30.50	13.00	33.32	3.20	2.10
		rear	28.80	11.40	33.32	3.20	3.30
	float	front	31.30	13.80	33.32	2.20	2.10
		rear	29.60	12.20	33.32	2.20	3.30
B	rigid	front	44.30	13.00	47.04	3.20	2.10
		rear	42.50	11.40	47.04	3.20	3.30
	float	front	45.10	13.80	47.04	2.20	2.10
		rear	43.30	12.20	47.04	2.20	3.30
C	rigid	front	60.70	13.00	63.50	3.20	2.10
		rear	59.10	11.40	63.50	3.20	3.30
	float	front	61.50	13.80	63.50	2.20	2.10
		rear	59.80	12.20	63.50	2.20	3.30
D	rigid	front	58.30	16.80	61.11	3.20	2.10
		rear	56.30	14.10	61.11	3.20	3.30
	float	front	59.20	16.80	61.11	2.20	2.10
		rear	57.20	14.40	61.11	2.20	3.30

panel cutouts: DH hermetic series

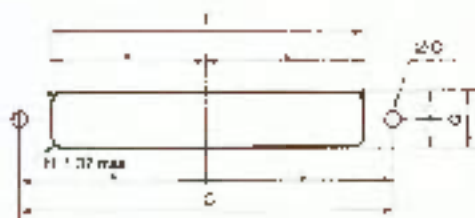

cutout for mounting from rear of panel (screw mounting)

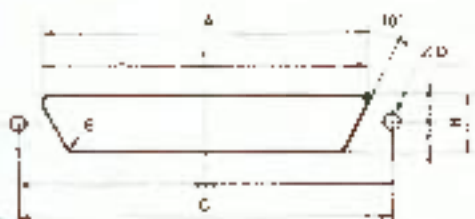

shell size	mounting position	A ±0.1	B ±0.1	C ±0.1	D ±0.05	E ±0.1	F min	G min
E	front			24.99	3.2	2.1	18.7	9.6
	rear	20.5	11.4	24.99	3.2	3.3		
A	front			33.32	3.2	2.1	23.9	9.6
	rear	28.8	11.4	33.32	3.2	3.3		
B	front			47.04	3.2	2.1	37.8	9.6
	rear	48.5	11.4	47.04	3.2	3.3		
C	front			63.5	3.2	2.1	54.2	8.6
	rear	59.1	11.4	63.5	3.2	3.3		
D	front			61.11	3.2	2.1	51.0	13.0
	rear	58.3	14.1	61.11	3.2	3.3		

Souriau/MIL-C-24308A qualified part numbers

Partial list and not including non-magnetic series.

series DM – solder

Rigid mount

US Government designation	Souriau standard part no.	Souriau MIL-C-24308 part no.	See pages
M24308/1-1	DEM 09S	DEM 09S-032	12/13
.. /1-2	DAM 15S	DAM 15S-032	..
.. /1-3	DBM 25S	DBM 25S-032	..
.. /1-4	DCM 37S	DCM 37S-032	..
.. /1-5	DDM 50S	DDM 50S-032	..
M24308/3-1	DEM 09P	DEM 09P-032	12/13
.. /3-2	DAM 15P	DAM 15P-032	..
.. /3-3	DBM 25P	DBM 25P-032	..
.. /3-4	DCM 37P	DCM 37P-032	..
.. /3-5	DDM 50P	DDM 50P-032	..

Float mount

US Government designation	Souriau standard part no.	Souriau MIL-C-24308 part no.	See pages
M24308/1-23	DEMF 09S	DEMF 09S-032	12/13
.. /1-24	DAMF 15S	DAMF 15S-032	..
.. /1-25	DBMF 25S	DBMF 25S-032	..
.. /1-26	DCMF 37S	DCMF 37S-032	..
.. /1-27	DDMF 50S	DDMF 50S-032	..
M24308/3-12	DEMF 09P	DEMF 09P-032	12/13
.. /3-13	DAMF 15P	DAMF 15P-032	..
.. /3-14	DBMF 25P	DBMF 25P-032	..
.. /3-15	DCMF 37P	DCMF 37P-032	..
.. /3-16	DDMF 50P	DDMF 50P-032	..

series 8630 crimp (with contacts)

Rigid mount

US Government designation	Souriau standard part no.	Souriau MIL-C-24308 part no.	See pages
M24308/2-1	8630 09S	SEMA 09S	16/17
.. /2-2	8630 15S	SAMA 15S	..
.. /2-3	8630 25S	SBMA 25S	..
.. /2-4	8630 37S	SCMA 37S	..
.. /2-5	8630 50S	SDMA 50S	..
M24308/4-1	8630 09P	SEMA 09P	16/17
.. /4-2	8630 15P	SAMA 15P	..
.. /4-3	8630 25P	SBMA 25P	..
.. /4-4	8630 37P	SCMA 37P	..
.. /4-5	8630 50P	SOMA 50P	..

Float mount

US Government designation	Souriau standard part no.	Souriau MIL-C-24308 part no.	See pages
M24308/2-342	8631 09S	SEMAF 09S	16/17
.. /2-343	8631 15S	SAMAF 15S	..
.. /2-344	8631 25S	SBMAF 25S	..
.. /2-345	8631 37S	SCMAF 37S	..
.. /2-346	8631 50S	SDMAF 50S	..
M24308/4-302	8631 09P	SEMAF 09P	16/17
.. /4-303	8631 15P	SAMAF 15P	..
.. /4-304	8631 25P	SBMAF 25P	..
.. /4-305	8631 37P	SCMAF 37P	..
.. /4-306	8631 50P	SDMAF 50P	..

Souriau/MIL-C-24308A cross reference list (series submitted for qualification)

series 8635 high density crimp (with contacts)

Rigid mount

US Government designation	Souriau standard part no.	Souriau MIL-C-24308 part no.	See pages
M24308/2-11	8635 15S	SEMA 15S	18/19
.. /2-12	8635 26P*	SAMA 26P*	..
.. /2-13	8635 44S	SBMA 44S	..
.. /2-14	8635 62S*	SCMA 62P*	..
.. /2-15	8635 78S	SDMA 78S	..
M24308/4-11	8635 15P*	SEMA 15P*	18/19
.. /4-12	8635 26P*	SAMA 26P*	..
.. /4-13	8635 44P*	SBMA 44P*	..
.. /4-14	8635 62P*	SCMA 62P*	..
.. /4-15	8635 78P	SDMA 78P	..

Float mount

US Government designation	Souriau standard part no.	Souriau MIL-C-24308 part no.	See pages
M24308/2-347	8635F 15S	SEMAF 15S	18/19
.. /2-348	8635F 26P*	SAMAF 26P*	..
.. /2-349	8635F 44S	SBMAF 44S	..
.. /2-350	8635F 62P*	SCMAF 62P*	..
.. /2-351	8635F 78S	SDMAF 78S	..
M24308/4-307	8635F 15P*	SEMAF 15P*	18/19
.. /4-308	8635F 26P*	SAMAF 26P*	18/19
.. /4-309	8635F 44P*	SBMAF 44P*	..
.. /4-310	8635F 62P*	SCMAF 62P*	..
.. /4-311	8635F 78P	SDMAF 78P	..

* Please consult us for availability