

ASJ

# DATA SHEET

## General Purpose Thick Film Chip Resistor

### CR Series

0.1% TO 5%, TCR  $\pm 100$  TO  $\pm 200$

SIZE: 0402/0603/0805/1206

RoHS-Compliant



# GENERAL PURPOSE THICK FILM CHIP RESISTOR

CR Series

DS-ENG-001

Page: 2 of 22

## 1. SCOPE

- 1.1 This specification specifies fixed thick film chip resistor (referred to as resistor hereinafter) for use in electronic equipment. In case there are discrepancies in specifications between this specification and the Customer's specifications, the latter shall precede.
- 1.2 The products are tested and passed based on the test conditions and methods defined in AEC-Q200.

## 2. PART NUMBERING SYSTEM

Part Numbering is made in accordance with the following system:

CR	10	XXXX	F	K	
Type	Size(Inch/mm)	Nominal Resistance		Resistance Tolerance	Packaging
General Purpose Thick Film Chip Resistors	10 (0402/1005) 16 (0603/1608) 21 (0805/2012) 32 (1206/3216)	2% 5% (3-Digit)	E24 Series 2.2Ω = 2R2 100Ω = 101	B = ±0.1% D = ±0.5% F = ±1% G = ±2% J = ±5%  Z=Zero Ohm (±5% only)	L=5,000 pcs Lead Free K=10,000 pcs Lead Free Y=20,000 pcs Lead Free *N=50,000 pcs Lead Free  Remark : *Applicable for CR10(0402/1005)
		0.1% 0.5% 1% (4-Digit)	E96 Series 10.2Ω = 10R2 10KΩ = 1002		
		1% 5% JUMPER (Zero Ohm)	JUMPER 1% = 0000 JUMPER 5% = 000		

## 3. RATING

### 3.1 Rated Power

#### 3.1.1 Zero Ohm Jumper Rated Power

	Rated Current Z (±5%)	Rated Current F (±1%)	JUMPER Resistance Value Z (±5%)	JUMPER Resistance Value F (±1%)
CR10	1A	1.5A	< 50mΩ	< 35mΩ
CR16	1A	2A	< 50mΩ	< 35mΩ
CR21	2A	2.5A	< 50mΩ	< 35mΩ
CR32	2A	3.5A	< 50mΩ	< 35mΩ

#### 3.1.2 Resistor Rated Power

	Rated Power	Maximum Working Voltage	Maximum Overload Voltage	Maximum Intermittent Overload Voltage	Dielectric Withstanding Voltage
CR10	1/16W	50V	100V	100V	300V
CR16	1/10W	75V	150V	100V	300V
CR21	1/8W	150V	300V	300V	500V
CR32	1/4W	200V	400V	400V	500V

# GENERAL PURPOSE THICK FILM CHIP RESISTOR

CR Series

DS-ENG-001

Page: 3 of 22

### 3.2 Power Derating Characteristics

Rated Power shall be the load power corresponding to nominal wattage suitable for continuous use at 70°C ambient temperatures. In case the ambient temperature exceeds 70°C, reduce the load power in accordance with Derating curve in Fig. 1.

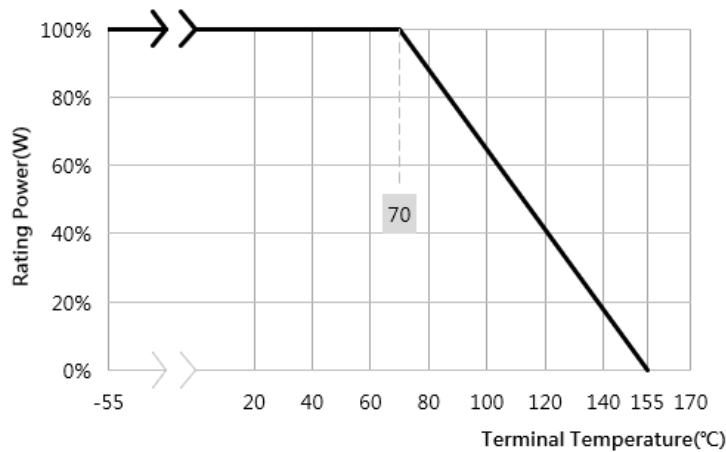

Fig.1 Power Derating Characteristics

### 3.3 Standard Atmospheric Condition

Unless otherwise specified, the standard range of atmospheric conditions for making measurements and tests is as follows:

Ambient Temperature = + 5°C to +35°C

Relative Humidity = < 85% RH

Air Pressure = 86 kPa to 106kPa

If there may be any doubt about the results, measurement shall be made within the following limits:

Ambient Temperature =  $20 \pm 2^\circ\text{C}$

Relative Humidity = 60 to 70% RH

Air Pressure = 86 kPa to 106kPa

3.4 Operating Temperature Range -55°C to +155°C

3.5 Storage Temperature Range -5°C to + 40°C / < 85% RH

3.6 Flammability Rating Tested in accordance to UL-94, V-0

3.7 Moisture Sensitivity Level Rating: Level 1

3.8 Product Assurance

ASJ resistor shall warranty 24 months from manufacturing date with control conditions.

3.9 ASJ resistors are RoHS-compliant in accordance to RoHS Directive.

# GENERAL PURPOSE THICK FILM CHIP RESISTOR

CR Series

DS-ENG-001

Page: 4 of 22

## 3.10 Resistance, Resistance Tolerance and Temperature Coefficient of Resistance.

Type	Rated Power At 70°C	Max. Working Voltage	Max. Overload Voltage	T.C.R. (ppm/°C)	Resistance Range				JUMPER Rated Current		JUMPER Resistance Value	
					B (±0.1%) E-24、E-96	D (±0.5%) E-24、E-96	F (±1%) E-24、E-96	G (±2%), J (±5%) E-24	Z (±5%)	F (±1%)	Z (±5%)	F (±1%)
CR10 (0402)	1/16W	50V	100V	±100	$20\Omega \leq R \leq 1M\Omega$	$10\Omega \leq R \leq 1M\Omega$	$10\Omega \leq R \leq 22M\Omega$	$10\Omega \leq R \leq 22M\Omega$	1A	1.5A	50mΩ MAX	35mΩ MAX
				±200	-----	$1\Omega \leq R < 10\Omega$	$1\Omega \leq R < 10\Omega$	$1\Omega \leq R < 10\Omega$				
CR16 (0603)	1/10W	75V	150V	±100	$100\Omega \leq R \leq 1M\Omega$	$10\Omega \leq R \leq 1M\Omega$	$10\Omega \leq R \leq 22M\Omega$	$10\Omega \leq R \leq 22M\Omega$	1A	2.0A	50mΩ MAX	35mΩ MAX
				±200	-----	$1\Omega \leq R < 10\Omega$	$1\Omega \leq R < 10\Omega$	$1\Omega \leq R < 10\Omega$				
CR21 (0805)	1/8W	150V	300V	±100	$100\Omega \leq R \leq 1.5M\Omega$	$10\Omega \leq R \leq 10M\Omega$	$10\Omega \leq R \leq 27M\Omega$	$10\Omega \leq R \leq 27M\Omega$	2A	2.5A	50mΩ MAX	35mΩ MAX
				±200	-----	$1\Omega \leq R < 10\Omega$	$1\Omega \leq R < 10\Omega$	$1\Omega \leq R < 10\Omega$				
CR32 (1206)	1/4W	200V	400V	±100	$10\Omega \leq R \leq 1M\Omega$	$10\Omega \leq R \leq 10M\Omega$	$10\Omega \leq R \leq 27M\Omega$	$10\Omega \leq R \leq 27M\Omega$	2A	3.5A	50mΩ MAX	35mΩ MAX
				±200	$3\Omega \leq R < 10\Omega$	$1\Omega \leq R < 10\Omega$	$1\Omega \leq R < 10\Omega$	$1\Omega \leq R < 10\Omega$				
Operating Temperature Range					-55°C ~ +155°C							

## 3.11 Rated Voltage

The rated voltage is calculated from the rated power and nominal resistance by the following formula:

$$E = \sqrt{P \cdot R}$$

Where E : Rated Voltage (V)  
 P : Rated Power (W)  
 R : Nominal Resistance (Ω)

In case the value calculated by the formula exceeds the maximum working voltage given in Section 3.1.2, the maximum working voltage in Section 3.1.2 shall be regarded as the rated voltage.

## 3.12 All product, product specifications and data are subject to change without notice to improve reliability, function or design or otherwise.



# GENERAL PURPOSE THICK FILM CHIP RESISTOR

CR Series









DS-ENG-001

Page: 5 of 22

## 4. MARKING ON PRODUCT

The nominal resistance shall be marked on the surface of each resistor

Type	Resistance Range	Tolerance $\leq 1\%$	Tolerance $> 1\%$
Sizes: CR10 (0402)	All	No Marking	
	Jumper = $0\Omega$		
Size: CR16 (0603)	$<1\Omega$	3-digits Marking	3-digits Marking
	$\geq 1\Omega$	3-digits Marking	3-digits Marking
	Jumper = $0\Omega$	1-digits Marking	1-digit Marking
Sizes: CR21 (0805) 、 CR32 (1206)	$<1\Omega$	4-digits Marking	4-digits Marking
	$\geq 1\Omega$	4-digits Marking	3-digits Marking
	Jumper = $0\Omega$	1-digits Marking	1-digit Marking

Marking	Description	Marking	Description
	No Marking - CR10		Tolerance: $\geq 1\Omega$ E-96, $\pm 0.1\%$ , $0.5\%$ , $1\%$ - CR16 (Special request) - CR21 - CR32 - Marking 1002 = $10K\Omega$ - Marking 10R2 = $10.2\Omega$ - Marking 1R02 = $1.02\Omega$
	The marking is expressed by "0" - CR16 - CR21 - CR32		
	Tolerance: $\geq 1\Omega$ E-96, $\pm 0.1\%$ , $0.5\%$ , $1\%$ EIA-96 marking - CR16(Standard Marking) - Marking 47B = $3.01K\Omega$		
	Tolerance: $\geq 1\Omega$ , E-24, $1\%$ - CR16(Standard Marking) - If the resistance is not in E-96 series and in E-24 series, the marking is expressed by one short bar under marking letter - Marking 471 = $470\Omega$		
 	Tolerance: $\geq 1\Omega$ , E-24, $2\%$ , $5\%$ - CR16 - CR21 - CR32 - Marking 100 = $10\Omega$ - Marking 4R7 = $4.7\Omega$		

# GENERAL PURPOSE THICK FILM CHIP RESISTOR

CR Series

DS-ENG-001

Page: 6 of 22

## 4.1 Numeric Numbering

### 4.1.1 5% Tolerance: **Three Numerals Marking**

First 2 digits are significant figures; third digit is number of zeros. Letter R is decimal point.

Example

<b>Nominal Resistance</b>	<b>Marking</b>	<b>Remarks</b>
1 Ω	1R0	$1 \times 10^0 = 1$
10 Ω	100	$10 \times 10^0 = 10$
100 Ω	101	$10 \times 10^1 = 100$
4.7K Ω	472	$47 \times 10^2 = 4700$
47K Ω	473	$47 \times 10^3 = 47000$
470K Ω	474	$47 \times 10^4 = 470000$
4.7M Ω	475	$47 \times 10^5 = 4700000$

### 4.1.2 1% Tolerance : **Four Numerals Marking**

First 3 digits are significant figures; fourth digit is number of zeros.

Examples:

<b>Nominal Resistance</b>	<b>Marking</b>	<b>Remarks</b>
1 Ω	1R00	$1 \times 10^0 = 1$
10 Ω	10R0	$10 \times 10^0 = 10$
100 Ω	1000	$100 \times 10^0 = 100$
4.7K Ω	4701	$470 \times 10^1 = 4700$
47K Ω	4702	$470 \times 10^2 = 47000$
470K Ω	4703	$470 \times 10^3 = 470000$
1M Ω	1004	$100 \times 10^4 = 1000000$

### 4.1.3 0603 1% Tolerance: **Three Character E-96 Marking Standard.**

The first 2 digits for the 3 digits E-96 part marking standard, (Refer Table 2).

The third character is a letter multiplier:

<b>Nominal resistance</b>	<b>Marking</b>	<b>Remark</b>
33.2 Ω	51 X	$332 \times 10^{-1} \Omega$
150 Ω	18 A	$150 \times 10^0 \Omega$
4.99K Ω	68 B	$499 \times 10^1 \Omega$
10.2K Ω	02 C	$102 \times 10^2 \Omega$
100K Ω	01 D	$100 \times 10^3 \Omega$

# GENERAL PURPOSE THICK FILM CHIP RESISTOR

CR Series

DS-ENG-001

Page: 7 of 22

## 4.1.3.1 EIA-96 Marking Scheme

Table 2 Significant Figures

Significant Figures	Symbol	Significant Figures	Symbol	Significant Figures	Symbol	Significant Figures	Symbol
100	01	178	25	316	49	562	73
102	02	182	26	324	50	576	74
105	03	187	27	332	51	590	75
107	04	191	28	340	52	604	76
110	05	196	29	348	53	619	77
113	06	200	30	357	54	634	78
115	07	205	31	365	55	649	79
118	08	210	32	374	56	665	80
121	09	215	33	383	57	681	81
124	10	221	34	392	58	698	82
127	11	226	35	402	59	715	83
130	12	232	36	412	60	732	84
133	13	237	37	422	61	750	85
137	14	243	38	432	62	768	86
140	15	249	39	442	63	787	87
143	16	255	40	453	64	806	88
147	17	261	41	464	65	825	89
150	18	267	42	475	66	845	90
154	19	274	43	487	67	866	91
158	20	280	44	499	68	887	92
162	21	287	45	511	69	909	93
165	22	294	46	523	70	931	94
169	23	301	47	536	71	953	95
174	24	309	48	549	72	976	96

$$Y=10^{-2} \quad X=10^{-1} \quad A=10^0 \quad B=10^1 \quad C=10^2 \quad D=10^3 \quad E=10^4 \quad F=10^5$$

## 4.1.3.2 Marking Table

E-24 series

10	11	12	13	15	16	18	20	22	24	27	30
33	36	39	43	47	51	56	62	68	75	82	91

E-96 series

100	102	105	107	110	113	115	118	121	124	127	130
133	137	140	143	147	150	154	158	162	165	169	174
178	182	187	191	196	200	205	210	215	221	226	232
237	243	249	255	261	267	274	280	287	294	301	309
316	324	332	340	348	357	365	374	383	392	402	412
422	432	442	453	464	475	487	499	511	523	536	549
562	576	590	604	619	634	649	665	681	698	715	732
750	768	787	806	825	845	866	887	909	931	953	976



Product Specification

Towards Excellence in Quality, Service & Innovation

# GENERAL PURPOSE THICK FILM CHIP RESISTOR

CR Series

DS-ENG-001

Page: 8 of 22

## 5. DIMENSION, CONSTRUCTION AND MATERIAL

### 5.1 Dimension

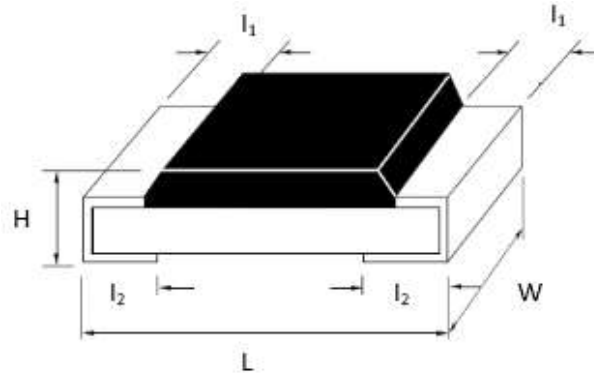

Unit: Inches (Millimeters)

CODE	L	W	H	l <sub>1</sub>	l <sub>2</sub>
CR10 (0402)	0.040±0.004 (1.00±0.10)	0.020±0.002 (0.50±0.05)	0.012±0.002 (0.30±0.05)	0.008±0.004 (0.20±0.10)	0.010±0.004 (0.25±0.10)
CR16 (0603)	0.063±0.004 (1.60±0.10)	0.031±0.004 (0.80±0.10)	0.018±0.004 (0.45±0.10)	0.012±0.006 (0.30±0.15)	0.012±0.006 (0.30±0.15)
CR21 (0805)	0.079±0.004 (2.00±0.10)	0.049±0.004 (1.25±0.10)	0.020±0.004 (0.50±0.10)	0.014±0.008 (0.35±0.20)	0.014±0.006 (0.35±0.15)
CR32 (1206)	0.120±0.004 (3.05±0.10)	0.061±0.004 (1.55±0.10)	0.020±0.004 (0.50±0.10)	0.018±0.008 (0.45±0.20)	0.014±0.006 (0.35±0.15)



# GENERAL PURPOSE THICK FILM CHIP RESISTOR

CR Series

DS-ENG-001

Page: 9 of 22

## 5.2 Zero Ohm Construction

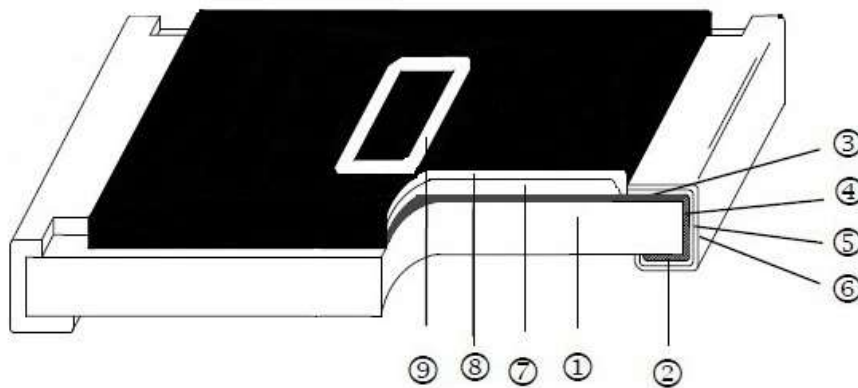

1	ALUMINA SUBSTRATE	6	PURE TIN PLATING
2	BOTTOM CONDUCTOR	7	OVERGLAZE
3	TOP CONDUCTOR	8	OVERCOAT
4	SPUTTERING EDGE TERMINAL	9	MARKING (CR10 No Marking)
5	NICKEL PLATING		

## 5.3 Resistor Construction

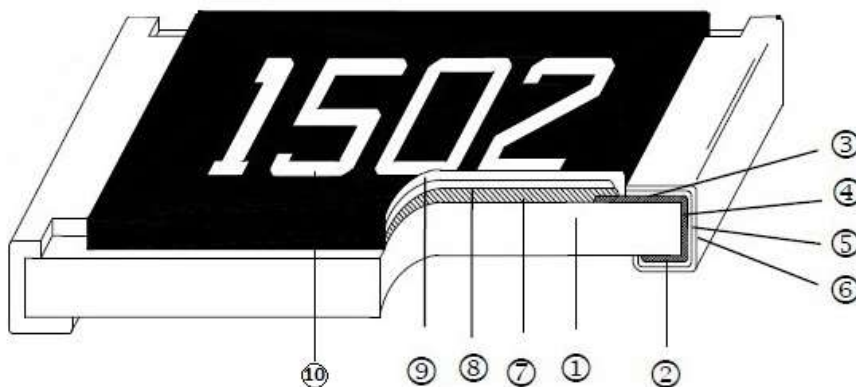

1	ALUMINA SUBSTRATE	6	PURE TIN PLATING
2	BOTTOM CONDUCTOR	7	RESISTOR
3	TOP CONDUCTOR	8	OVERGLAZE
4	SPUTTERING EDGE TERMINAL	9	OVERCOAT
5	NICKEL PLATING	10	MARKING (CR10 No Marking)

# GENERAL PURPOSE THICK FILM CHIP RESISTOR

CR Series

DS-ENG-001

Page: 10 of 22

## 6. ELECTRICAL CHARACTERISTICS AND TEST CONDITIONS

CHARACTERISTICS		SPECIFICATIONS		TESTING CONDITIONS														
		ZERO OHM	RESISTANCE															
1	Resistance Value	≤ 50 mΩ For 5% (Z)	Resistance accuracy being fully relies with respect to tolerance of resistor.	<p><b>JIS C 5201-1 4.5</b> Application time to be within 5 secs.</p> <p>Applied Voltage for resistance measurement:</p> <table border="1"> <tr> <td>&lt;10Ω</td> <td>0.1V</td> </tr> <tr> <td>10 ~ 99Ω</td> <td>0.3V</td> </tr> <tr> <td>100 ~ 999</td> <td>1.0V</td> </tr> <tr> <td>1k ~ 9.9k</td> <td>3.0 V</td> </tr> <tr> <td>10k ~ 99.9k</td> <td>10.0 V</td> </tr> <tr> <td>100k ~ 999k</td> <td>25.0 V</td> </tr> <tr> <td>1M &amp; Over</td> <td>50.0 V</td> </tr> </table>	<10Ω	0.1V	10 ~ 99Ω	0.3V	100 ~ 999	1.0V	1k ~ 9.9k	3.0 V	10k ~ 99.9k	10.0 V	100k ~ 999k	25.0 V	1M & Over	50.0 V
<10Ω	0.1V																	
10 ~ 99Ω	0.3V																	
100 ~ 999	1.0V																	
1k ~ 9.9k	3.0 V																	
10k ~ 99.9k	10.0 V																	
100k ~ 999k	25.0 V																	
1M & Over	50.0 V																	
2	Resistance Temperature Coefficient	NA	Refer Section 3.10 Table 1	<p><b>MIL-STD-202 Method 304</b> Measure R at t<sub>0</sub>=25°C and after 45 minutes measure R at t=125°C. <i>Calculation :</i> <math>TCR(ppm/^{\circ}C) = \frac{R-R_0}{R_0(t-t_0)} \times 10^6</math></p>														
3	Voltage Coefficient (Applicable for > 1kΩ only)	NA	Voltage coefficient ≤ 100ppm/V	<p><b>JIS C 5201-1 4.11</b> Measured resistance R<sub>2</sub> at 100%V rated voltage or the limiting element voltage (&gt; 0.5s in every 5s) and R<sub>1</sub> 10% V (4.5s)</p> <p><i>Calculation :</i> <math>V_c = \frac{R_2 - R_1}{0.9 \times U \times R_1}</math></p>														
4	Short Time Overload	≤ 50 mΩ For 1% and 5% tolerance resistor	± 0.5% for 1% tolerance resistor ± 1.0% for 5% tolerance resistor	<p><b>JIS C 5201-1 4.13</b> Apply at 2.5 times rated voltage for 5 seconds. Applied voltage shall not exceed maximum overload voltage or current.</p>														

CHARACTERISTICS	SPECIFICATIONS	TESTING CONDITIONS
-----------------	----------------	--------------------



Product Specification

Towards Excellence in Quality, Service & Innovation

# GENERAL PURPOSE THICK FILM CHIP RESISTOR

CR Series

DS-ENG-001

Page: 11 of 22

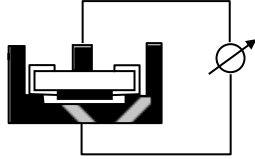
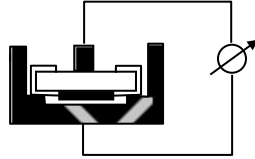
		ZERO OHM	RESISTANCE		
5	Insulation Resistance	> 10G Ω			<p><b>JIS C 5201-1 4.6</b> Apply (100 ±15) Vdc for 1 minute. Measured the insulation resistance between electrodes and insulating enclosure or between electrodes and base.</p> 
6	Dielectric Withstanding Voltage	No failure of resistor such as short-circuit, burning, breakdown.		<p><b>JIS C 5201-1 4.7</b> Apply 500Vac for 1 minute ± 5secs. for chip ≥ 0805. Apply 300Vac for 1 minute ± 5secs. for chip 0402 &amp; 0603 Apply 50Vac for 1 minute ± 5secs for 0201</p>  <p>The variation in relation to the initial resistance shall be within ± 1%.</p>	
		≤ 50 mΩ For 1% & 5% tolerance resistor	± (1%+0.05Ω) for 1% & 5% tolerance resistor		
7	Intermittent Overload	≤ 100mΩ For 1% & 5% tolerance resistor	±(5%+0.1Ω) for 1% & 5% tolerance resistor		<p><b>JIS C 5201-1 4.13</b> Apply 2.5 times rated voltage for 1 secs ON and 25 secs OFF. Total 10,000<sup>+400</sup><sub>-0</sub> cycles. Applied voltage/current shall not exceed maximum intermittent overload voltage/current.</p> <p><b>IEC 60115-1 4.39</b> 2.5 times of rated voltage or maximum overload voltage whichever is less for 1 sec ON and 25 secs OFF. Total 10,000<sup>+400</sup><sub>-0</sub> cycles.</p>
8	Noise	NA	1 ~ 9 10 ~ 99 100 ~ 999 1k ~ 9.9k 10k ~ 99.9k 100k ~ 9 99.9k >1M	-10dB(0.32μv/v) - 5 dB(0.52μv/v) 0 dB(1.0μv/v) 10 dB(3.2μv/v) 18 dB(5.6μv/v) 20 dB(10μv/v) 30 dB(32μv/v)	<p><b>JIS C 5201-1 4.12</b> Vo(dB) = T-f(T-S)-D</p>

# GENERAL PURPOSE THICK FILM CHIP RESISTOR

CR Series

DS-ENG-001

Page: 12 of 22

CHARACTERISTICS	SPECIFICATIONS		TESTING CONDITIONS
	ZERO OHM	RESISTANCE	
9 Terminal Strength  A) Bend Test (Applicable for chip size smaller than 1210) B) Pull Test (Applicable for chip size bigger than 0805) C) Push Test (Applicable for chip size bigger than 0805) D) Robustness test	≤ 50mΩ For 1% & 5% tolerance resistor	Tolerance resistor. With no evidence of mechanical damage after releasing the pressure.  ± (0.5%+ 0.05Ω) for 1% & 5%  ± 1% for 1% & 5%  ± (1.0%+0.05Ω) for 1% & 5%  After reading/initial reading ≥5N	<b>JIS C 5201-1 4.16</b>  Board Flex : Apply force till 2mm bend and hold for 60 ± 5 secs. Measure resistance while applying pressure.  <b>JIS C 5201-1 4.16.2</b> Pull Test : Apply 0.5kgF for 30 sec  Push Test : Apply 1.8kgF for 60 ± 1secs  Component mounted on board precondition using steam aging for 4 hour. Initial reading = Force required to break away components mounted on board. After Reading = Force required to break away components mounted on board after preconditioned.
10 Resistance to Soldering Heat	≤ 50mΩ For 1% & 5% tolerance resistor	± (0.5%+0.05Ω) for 1% & 5% tolerance resistor	<b>MIL-STD-202 Method 210</b> The specimens are tested in the test condition K (reflow) and measure its resistance variance rate. Time above : 217°C, 60sec - 150sec.
11 Solderability	≥ 95% Coverage at all terminal		<b>J-STD-002</b> ▪ SMD: Method B1, Coating Durability Category 2 Method D, Coating Durability Category 2 - Magnification 50x -Pre and Post Electrical Test not required. -Non-soldered type mounting/attach are not applicable.

CHARACTERISTICS	SPECIFICATIONS		TESTING CONDITIONS
	ZERO OHM	RESISTANCE	



Product Specification

*Towards Excellence in Quality, Service & Innovation*

# GENERAL PURPOSE THICK FILM CHIP RESISTOR

CR Series

DS-ENG-001

Page: 13 of 22

12	Resistance to Solvent	$\leq 50\text{m}\Omega$ For 1% & 5% tolerance resistor	Passed without any damaged to marking & protective material.	<b>MIL-STD-202 Method 215</b> Immerse in $25^\circ\text{C} \pm 5^\circ\text{C}$ Isopropyl Alcohol (IPA) for $3 \pm 0.5$ minutes.
13	High Temperature	$\leq 100\text{m}\Omega$ For 1% & 5% tolerance resistor	$\pm (0.5\%+0.05\Omega)$ for 1% tolerance resistor  $\pm (1\%+0.05\Omega)$ for 5% tolerance resistor	<b>MIL-STD-202 Method 108</b> 1000 hours @ $T = 155^\circ\text{C}$ . Unpowered measurement at $24 \pm 2$ hours after test conclusion.
14	Temperature Cycling	$\leq 50\text{m}\Omega$ For 1% & 5% tolerance resistor	$\pm (0.5\%+0.05\Omega)$ for 1% tolerance resistor  $\pm (1\%+0.05\Omega)$ for 5% tolerance resistor	<b>JESD 22 Method JA-104</b> 1000 cycles ( $-55^\circ\text{C}$ to $155^\circ\text{C}$ ) measurement at $24 \pm 2$ hours after test conclusion.
15	Resistance to damp Heat (Humidity)	$\leq 100\text{m}\Omega$ For 1% & 5% tolerance resistor	$\pm (1\%+0.1\Omega)$ for 1% & 5% tolerance resistor	<b>JIS-C5201-1 4.24</b> Put the tested resistor in the chamber under temperature $40\pm 2^\circ\text{C}$ , relative humidity 90~95% and load the rated voltage for 90 minutes on, 30 minutes off, total 1000 hours. Then leaving the tested resistor in room temperature for 60 minutes, and measure its resistance variance rate.
16	Load life	$\leq 100\text{m}\Omega$ For 1% & 5% tolerance resistor	$\pm (1.0\%+0.05\Omega)$ for 1% tolerance resistor  $\pm (2.0\%+0.1\Omega)$ for 5% tolerance resistor	<b>MIL-STD-202 Method 108</b> At $70 \pm 3^\circ\text{C}$ Apply DC rated voltage at 90minutes On, 30minutes Off for $1000_{-0}^{+48}$ hours Sample shall be left at ambient temperature for $1 \sim 2$ hrs after test before measuring final resistance.
17	Salt Spray	$\leq 50\text{m}\Omega$ For 1% & 5% tolerance resistor	$\pm (3\%+0.1\Omega)$ for 1% & 5% tolerance resistor	<b>MIL-STD-202 Method 101</b> Spray $5 \pm 1$ Wt% salt water for $96\pm 4$ hours at $35\pm 2^\circ\text{C}$
18	Mounting Quality Test	$\leq 50\text{m}\Omega$ For 1% & 5% tolerance resistor	Visual check for solder joint wetting condition, resistor body damages	<b>JESD22-B102E</b> Solder Paste: Sn-3Ag-0.5Cu Reflow soldering method Peak : $250_{-0}^{+5}^\circ\text{C}$ and $230 \pm 5^\circ\text{C}$ for 60sec

## 6.1 Soldering Profile



Product Specification

Towards Excellence in Quality, Service & Innovation

# GENERAL PURPOSE THICK FILM CHIP RESISTOR

CR Series

DS-ENG-001

Page: 14 of 22

## 6.1.1 Wave Soldering

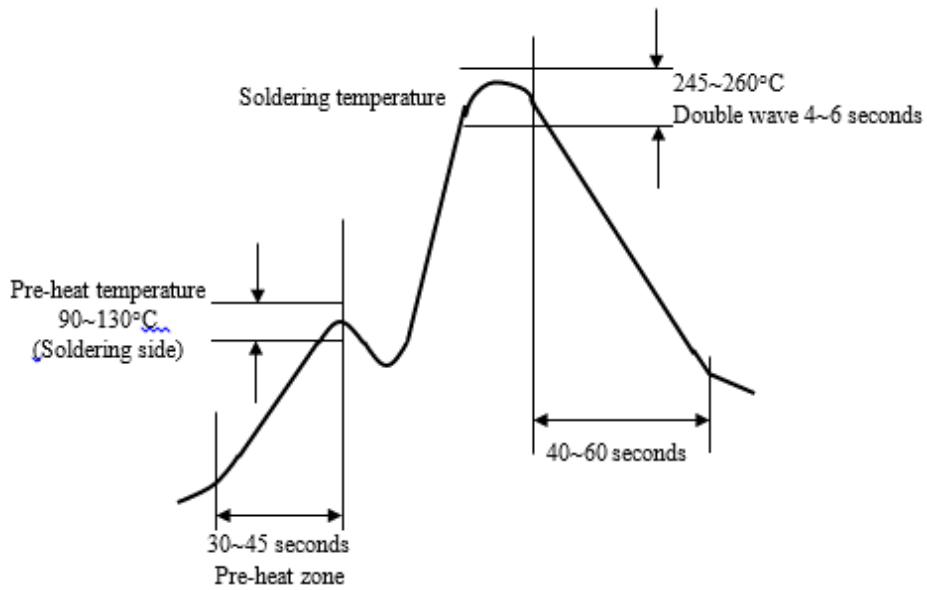

## 6.1.2 Reflow Soldering

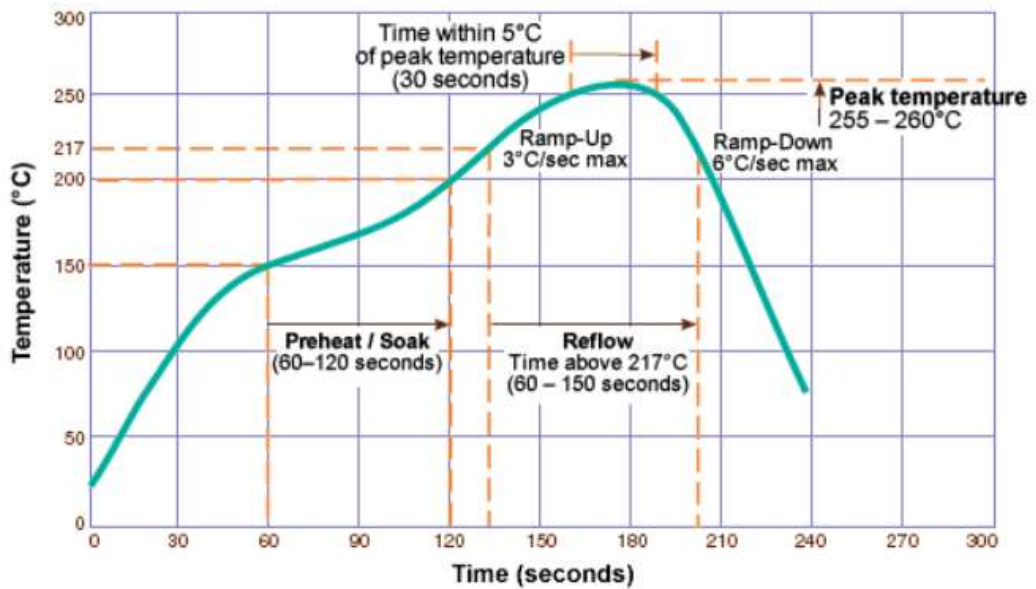

6.1.3 Soldering Iron : Temperature  $350^{\circ}\text{C} \pm 10^{\circ}\text{C}$ , dwell time shall be less than 3 sec.

## 7. TAPING



Product Specification

Towards Excellence in **Quality, Service & Innovation**

# GENERAL PURPOSE THICK FILM CHIP RESISTOR

CR Series

DS-ENG-001

Page: 15 of 22

## 7.1 Structure of Taping

### Paper Carrier

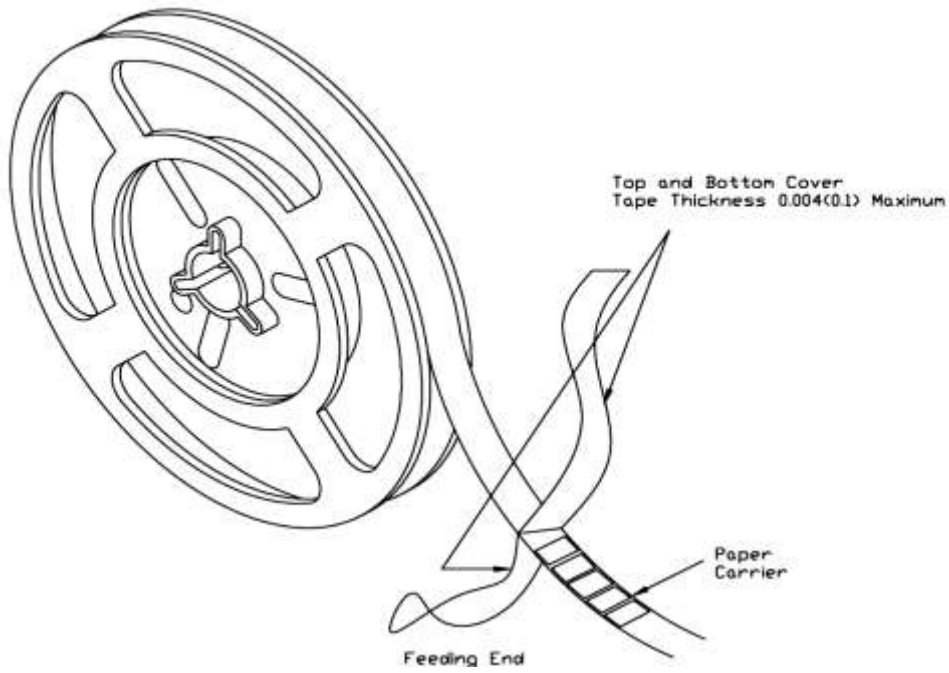

### Embossed Plastic Carrier

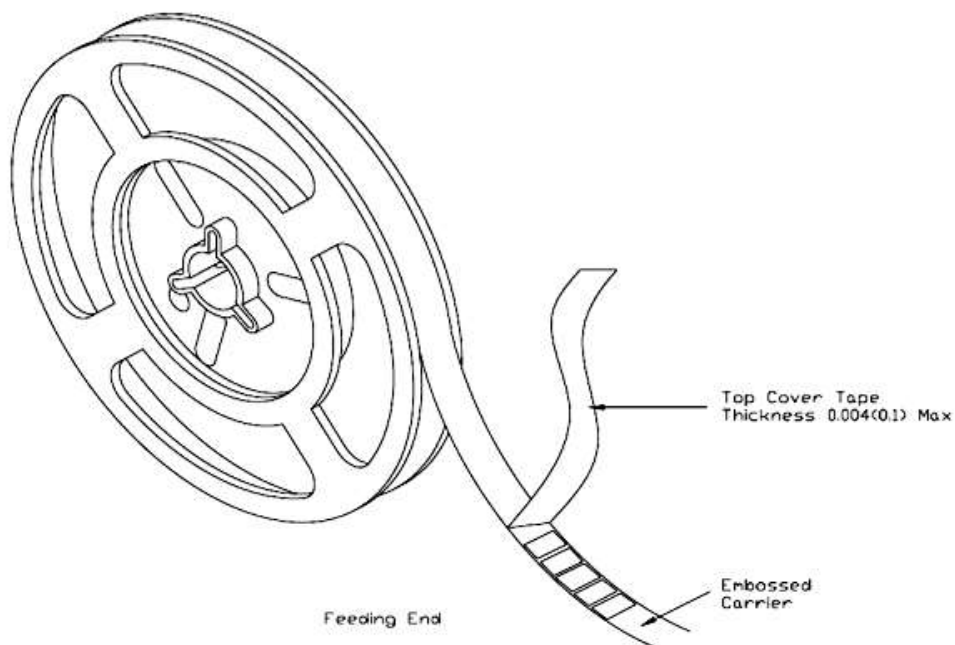

## 7.2 Dimension



Product Specification

*Towards Excellence in Quality, Service & Innovation*

# GENERAL PURPOSE THICK FILM CHIP RESISTOR

CR Series

DS-ENG-001

Page: 16 of 22

## 7.2.1 Dimension of Punched Paper Tape Carrier System (CR -03, 05, 10)

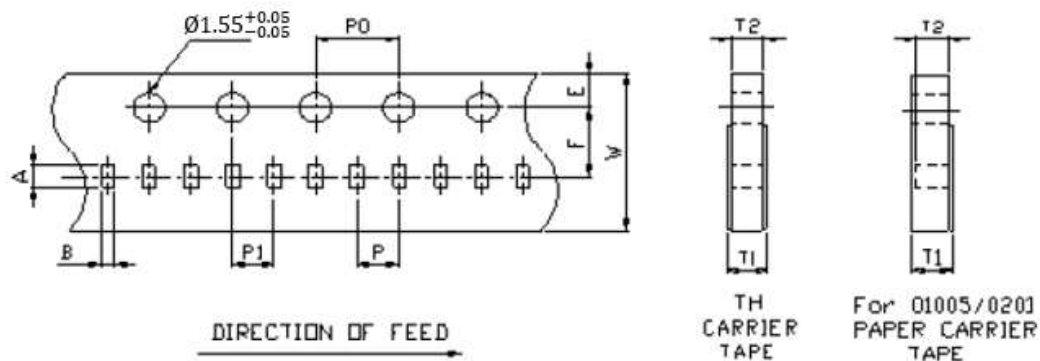

Remark: Pitch tolerance over any 10 pitches of  $P_0$  is  $\pm 0.2$  mm

## Dimension of Punched Paper Tape Carrier System (CR-03, 05, 10)

(unit : mm)

Code	A	B	W	E	F	T1
CR10	$1.15 \pm 0.03$	$0.65 \pm 0.03$	$8.00 \pm 0.10$	$1.75 \pm 0.10$	$3.50 \pm 0.05$	$0.42^{+0.2}_{-0}$

Code	T2	P	P0	10xP0	P1
CR10	$0.42^{+0.03}_{-0.03}$	$2.00 \pm 0.05$	$4.00 \pm 0.10$	$40.0 \pm 0.20$	$2.00 \pm 0.05$

## 7.2.2 Dimension of Punched Paper Tape Carrier System /Plastic Embossed Carrier System (CR16, 21, 32, 40)



Product Specification

Towards Excellence in **Quality, Service & Innovation**



# GENERAL PURPOSE THICK FILM CHIP RESISTOR

CR Series

DS-ENG-001

Page: 17 of 22

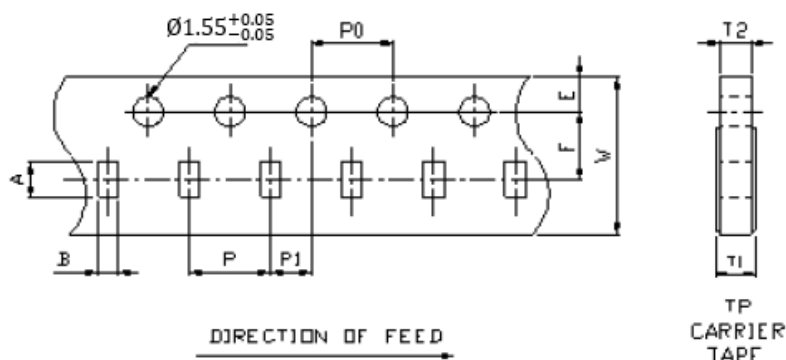

Remark : Pitch tolerance over any 10 pitches of  $P_0$  is  $\pm 0.2$  mm

## Dimension of Punched Paper Tape Carrier System (CR - 16, 21, 32, 40)

Code	A	B	W	E	F	T1	T2	P	P0	P1
CR16	$1.8 \pm 0.10$	$1.0 \pm 0.10$	$8.0 \pm 0.10$	$1.75 \pm 0.10$	$3.50 \pm 0.05$	$0.60^{+0.2}_{-0}$	$0.60^{+0.03}_{-0.03}$	$4.0 \pm 0.05$	$4.0 \pm 0.10$	$2.0 \pm 0.05$
CR21	$2.33 \pm 0.05$	$1.58 \pm 0.05$	$8.0 \pm 0.10$	$1.75 \pm 0.10$	$3.50 \pm 0.05$	$0.75^{+0.2}_{-0}$	$0.75^{+0.03}_{-0.05}$	$4.0 \pm 0.05$	$4.0 \pm 0.10$	$2.0 \pm 0.05$
CR32	$3.30 \pm 0.05$	$1.90 \pm 0.05$	$8.0 \pm 0.10$	$1.75 \pm 0.10$	$3.50 \pm 0.05$	$0.75^{+0.2}_{-0}$	$0.75^{+0.03}_{-0.05}$	$4.0 \pm 0.05$	$4.0 \pm 0.10$	$2.0 \pm 0.05$
CR40	$3.5 \pm 0.2$	$2.8 \pm 0.2$	$8.0 \pm 0.20$	$1.75 \pm 0.10$	$3.50 \pm 0.05$	$0.75^{+0.2}_{-0}$	$0.75^{+0.1}_{-0.0}$	$4.0 \pm 0.10$	$4.0 \pm 0.05$	$2.0 \pm 0.05$

## 7.3 Packaging

### 7.3.1 Taping

#### Quantity – Tape and Reels

Code	Quantity	Model	Remarks
CR10	10,000 pcs	7" Reel	2mm pitch
	20,000 pcs	7" Reel	2mm pitch
	50,000 pcs	13" Reel	2mm pitch
CR16 CR21 CR32	5,000 pcs	7" Reel	4mm pitch
	10,000 pcs	10" Reel	4mm pitch
	20,000 pcs	13" Reel	4mm pitch

### 7.3.3 Identification

Production label that indicates the 10 digits lot number, product type,



Product Specification

Towards Excellence in Quality, Service & Innovation

# GENERAL PURPOSE THICK FILM CHIP RESISTOR

CR Series

DS-ENG-001

Page: 18 of 22

resistance value and tolerance shall be pasted on the surface of each reel.

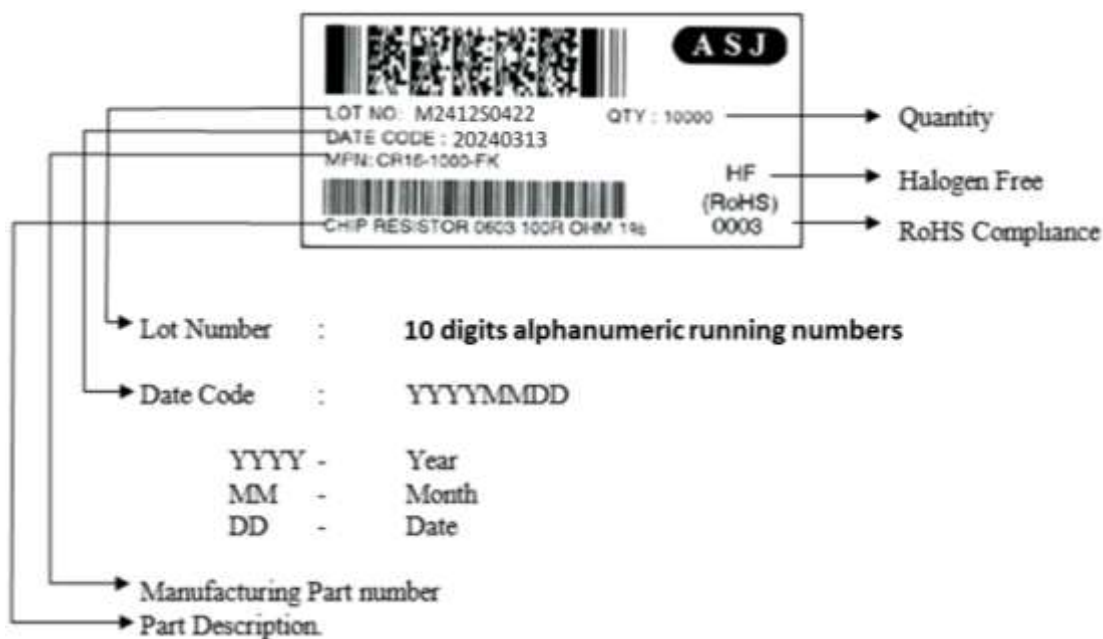

### 7.3.4 Packaging Reel Box

Dimension	Reel Box	Number of Reels
185 × 60 × 186 mm	25K Box	5
185 × 120 × 186 mm	50K Box	10

### 7.3.5 Reel Dimensions



Product Specification

*Towards Excellence in Quality, Service & Innovation*

# GENERAL PURPOSE THICK FILM CHIP RESISTOR

CR Series

DS-ENG-001

Page: 19 of 22

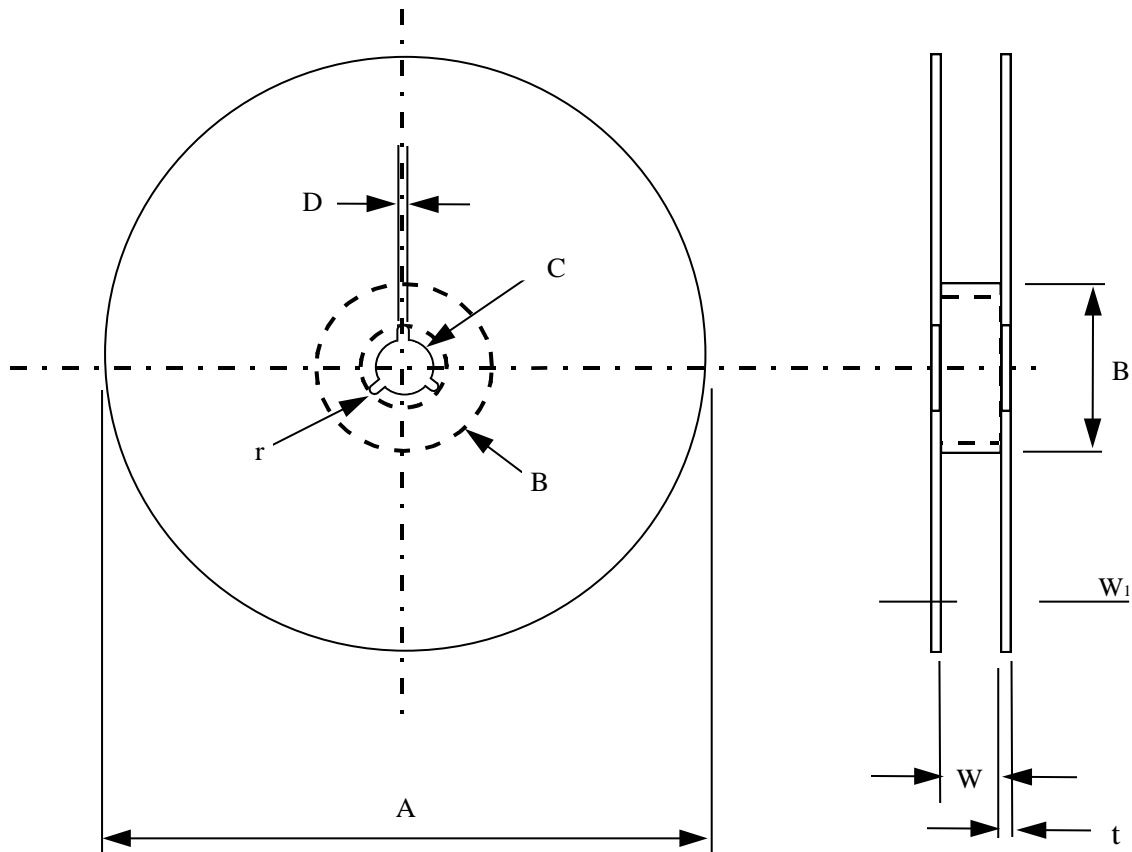

Model	A	B	C	D	W	W <sub>1</sub>	t	r
7"Reel (5K) (except 0402 10K)	$\phi 178 \pm 2.0$	$\phi 60 \text{min}$	$13 \pm 0.2$	$\phi 2.0 \pm 0.5$	$11 \pm 0.1$	14.4 max	$1.0 \pm 0.1$	1.0
7"Reel (4K)	$\phi 178 \pm 2.0$	$\phi 60 \text{min}$	$13 \pm 0.2$	$\phi 2.0 \pm 0.5$	$13 \pm 1.0$	14.4 max	$1.2 \pm 0.1$	1.0
7"Reel (10K)	$\phi 178 \pm 2.0$	$\phi 60 \text{min}$	$13 \pm 0.2$	$\phi 2.0 \pm 0.5$	$11 \pm 0.1$	14.4 max	$1.0 \pm 0.1$	1.0
10"Reel (10K)	$\phi 254 \pm 2.0$	$\phi 60 \text{min}$	$13 \pm 0.2$	$\phi 2.0 \pm 0.5$	$11 \pm 1.0$	14.4 max	$1.5 \pm 0.1$	1.0
13"Reel (20K, 50K)	$\phi 330 \pm 2.0$	$\phi 60 \text{min}$	$13 \pm 0.2$	$\phi 2.0 \pm 0.5$	$11 \pm 1.0$	14.4 max	$2.1 \pm 0.1$	-
13"Reel (20K)	$\phi 330 \pm 1.0$	$\phi 100 \pm 1$	$13.5 \pm 0.5$	$2 \sim 3 \pm 0.5$	$10 \pm 0.5$	-	-	-

## 8. SURFACE MOUNT LAND PATTERNS



Product Specification

Towards Excellence in Quality, Service & Innovation

# GENERAL PURPOSE THICK FILM CHIP RESISTOR

CR Series

DS-ENG-001

Page: 20 of 22

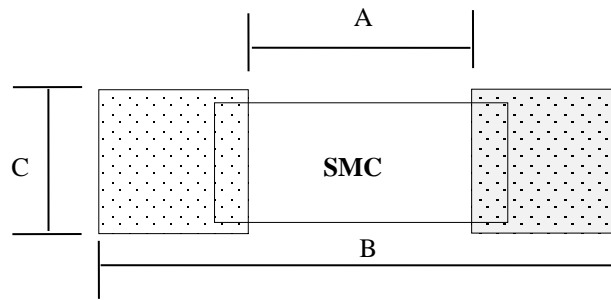

Product ( Type )	Land Dimension		
	A	B	C
CR10 (0402)	0.020 [0.5]	0.059 [1.5]	0.024 [0.6]
CR16 (0603)	0.031 [0.8]	0.083 [2.1]	0.035 [0.9]
CR21 (0805)	0.047 [1.2]	0.118 [3.0]	0.051 [1.3]
CR32 (1206)	0.087 [2.2]	0.165 [4.2]	0.063 [1.6]

## 9. REVISION HISTORY



Product Specification

*Towards Excellence in Quality, Service & Innovation*

# GENERAL PURPOSE THICK FILM CHIP RESISTOR

CR Series

DS-ENG-001

Page: 21 of 22

REVISION	DATE	CHANGE NOTIFICATION	DESCRIPTION
Version.1	13.02.2015		Initial Release
Version.2	19.02.2016	Refer to ECO No. : 001/2016	Change 0201 I1 dimension from 0.15±0.05 mm to 0.10±0.05 mm
Version.3	25.03.2016		Revise clause 6.1.1, typo error, change IR Reflow to Wave Soldering, 6.1.2, change Wave soldering to Reflow Soldering.
Version.4	08.06.2016		Revise clause 7.2.1, change dimension of punch paper carrier system for CR03, 05, 10 Revise clause 7.2.2, change dimension of punch paper carrier system for CR16, CR21, CR32, CR40, CR50, CR63
Version.5	06.12.2016	Refer to PCN-ECO :01/2016	Update clause 7.3.4, insert 13" reel information
Version.6	06.04.2017		Typo error in clause 5.1 review and update dimension
Version.7	19.05.2017		Insert product 01005 into clause 1.2
Version.8	14.09.2017		Update clause 7.2.1 & 7.2.2 dimension information
Version.9	05.10.2017		Review and update clause 7.3.2 Packaging information
Version.10	29.11.2019	Refer to PCR-004/17	Review clause 6 test condition Revise clause 7.2, update dimension of punch paper tape
Version.11	22.01.2018		Typo Error in clause 2
Version.12	18.09.2018		Revise clause 2 000-5% to 000, Remove 0000-1%
Version.13	27.03.2019		Remove CR03, CR05, CR40, CR50, CR63 product Update clause 3.2 graph Update clause 3.10 table Update clause 4 table Update clause 6 Update clause 7.2.1 & 7.2.2 table Update clause 7.3.2 table Update clause 8 table
Version.14	30.05.2019		Update clause 3.9
Version.15	09.07.2019		Update clause 3.9 & 3.10 Add in clause 6.1.3
Version.16	10.09.2019		Add in clause 5.2, 5.3 construction and material
Version.17	22.05.2020		Revise clause 3.10 TCR table, add 0.1% and 0.5% Revise clause 3.5 Revise clause 6
Version.18	18.01.2021		Revise clause 3.1.1 Revise clause 3.10
Version.19	26.01.2021		Revise clause 2 Part Numbering System Revise clause 4 Marking on product Add clause 4.1.3.2 Marking table
Version.20	04.03.2021		Revise clause 3.1.2 Resistor rated power
Version.21	01.09.2022		Revise clause 3.8 Product Assurance

# GENERAL PURPOSE THICK FILM CHIP RESISTOR

CR Series

DS-ENG-001

Page: 22 of 22

REVISION	DATE	CHANGE NOTIFICATION	DESCRIPTION
Version.22	01.03.2023		Revise clause 6 item 13 High Temperature test Revise clause 5.1 Dimensions; H dimension
Version 23	07.08.2023		Revise clause 6 Characteristics 10 Resistance to Soldering Heat details. Revise clause 6 Characteristics 11 Solderability details. Revise clause 6 Characteristics 14 Temperature Cycling temperature.
Version 24	27.09.2023		Revise clause 3.10 table.
Version 25	10.10.2023		Revise clause 3.10 table, Resistance Range
Version 26	12.12.2023		Revise clause 5.1 Dimension table
Version 27	01.04.2024		Revise clause 7.3.3 Identification
Version 28	10.06.2024		Revise clause 2 Part Numbering System. Revise clause 6.1.2 Reflow Soldering.



Product Specification

*Towards Excellence in Quality, Service & Innovation*