

REV. A

MODEL: R1610G-□A1
X

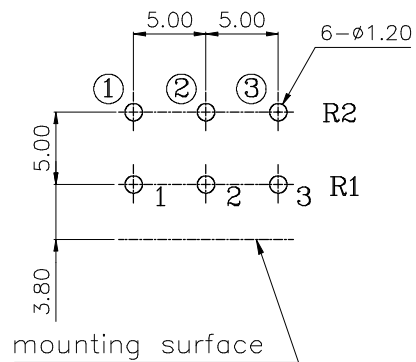
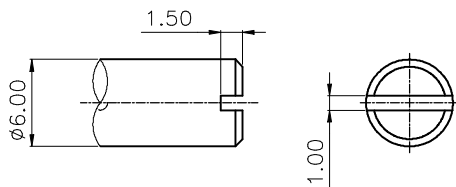
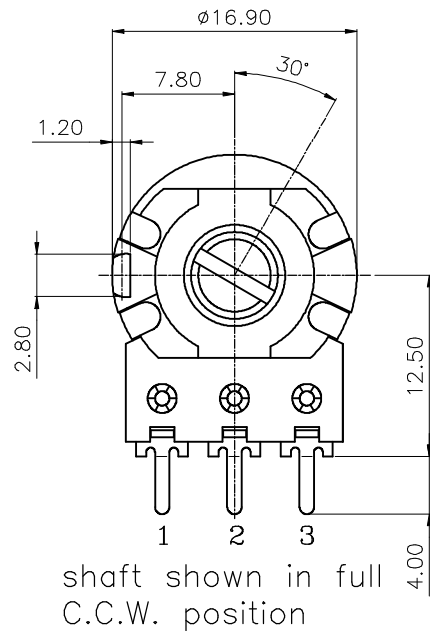
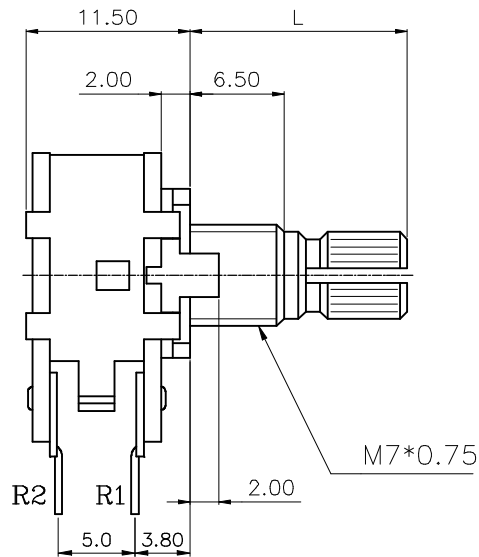

S TYPE:

X	P	Q	R	S	T	U
L	10	15	20	25	30	40

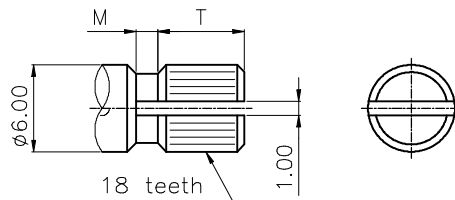
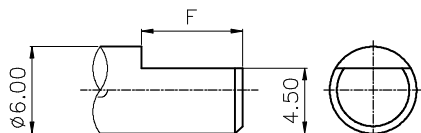

F TYPE:

X	A	B	C	D
L	15	20	25	30
F	7	12	12	12

KQ TYPE:

X	0	1	2	7	8	3	4	5
L	10	12	15	17	18	20	25	30
T	2.3	3.5	6	7	8	9.9	12.1	12
M	0.3	0.5	1	1.5	1.5	1.5	2	2

MODEL: R1610G-

Mechanical characteristics:機械的性能:

Item<項目>	Performance<性能>
Total rotational angle/travel 全迴轉角度/行程	300°±5°
Rotation torque 迴轉扭力	20~200 gf-cm
Shaft rotational stopper strength 軸的止迴轉強度	7 kgf-cm
Push-pull strength 軸推拉強度	7 kgf
Click position C.C.位置	Center click, 11/21/31/41 detent

Electrical characteristics:電氣的性能:

Item<項目>	Performance<性能>
Resistance taper 阻值線性	A/B/C

Reference: Standard resistance tapers in reference to rotational angles(travel) are as shown below:
參考:標準阻值曲線及旋轉角度(行程)表示如下:

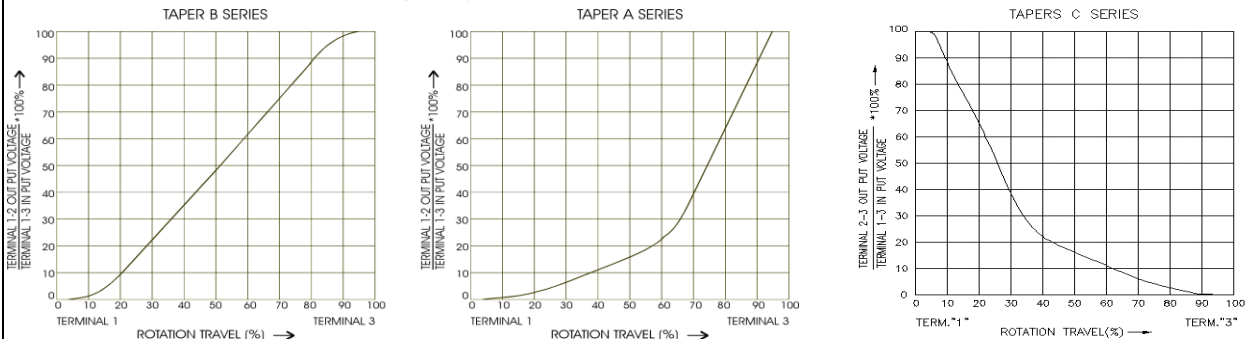

Total resistance 總阻值	5KΩ~2MΩ
Total resistance tolerance 總阻值容許差	±20% (more than 1MΩ±30%)
Max. operating voltage 最高使用電壓	B curve:200V Other than curve B:150V
Rated power 定格電力	B curve:0.125W Other than B curve:0.06W
Residual resistance 殘留阻值	$R \geq 250K\Omega$ 0.1% max. of total resistance $250K\Omega > R > 10K\Omega$ 20Ω max. $10K\Omega \geq R$ 10Ω max.
Rotational/sliding noise 迴轉/滑動雜音	Less than 100mV
Insulation resistance 絕緣抵抗	More than 100MΩ at DC 500V
Gang error 相互偏差(同步)	-40 to 0dB dB ≤ 3dB
Manual Soldering heat 手焊錫溫度	Below 300°C, Less than 3 seconds.

Durability:耐久的性能:

Item<項目>	Performance<性能>
Rotational/sliding life 迴轉/滑動壽命	15,000 cycles (15,000 次)